

# **Waters 2414 Refractive Index Detector Operator's Guide**

71500241402/Revision B

**Waters**  
THE SCIENCE OF WHAT'S POSSIBLE.™

Copyright © Waters Corporation 2008  
All rights reserved



## Copyright notice

---

© 2008 WATERS CORPORATION. PRINTED IN THE UNITED STATES OF AMERICA AND IRELAND. ALL RIGHTS RESERVED. THIS DOCUMENT OR PARTS THEREOF MAY NOT BE REPRODUCED IN ANY FORM WITHOUT THE WRITTEN PERMISSION OF THE PUBLISHER.

The information in this document is subject to change without notice and should not be construed as a commitment by Waters Corporation. Waters Corporation assumes no responsibility for any errors that may appear in this document. This document is believed to be complete and accurate at the time of publication. In no event shall Waters Corporation be liable for incidental or consequential damages in connection with, or arising from, its use.

## Trademarks

---

Alliance, Millennium, and Waters are registered trademarks of Waters Corporation, and Empower, ExpertEase, LAC/E, PowerLine, SAT/IN, and “THE SCIENCE OF WHAT’S POSSIBLE”, are trademarks of Waters Corporation.

PEEK is a registered trademark of Victrex plc.

Tygon is a registered trademark of Saint-Gobain Corporation.

Other registered trademarks or trademarks are the sole property of their owners.

## Customer comments

---

Waters' Technical Communications department invites you to tell us of any errors you encounter in this document or to suggest ideas for otherwise improving it. Please help us better understand what you expect from our documentation so that we can continuously improve its accuracy and usability.

We seriously consider every customer comment we receive. You can reach us at [tech\\_comm@waters.com](mailto:tech_comm@waters.com).



## Contacting Waters

---

Contact Waters<sup>®</sup> with enhancement requests or technical questions regarding the use, transportation, removal, or disposal of any Waters product. You can reach us via the Internet, telephone, or conventional mail.

### Waters contact information

| Contacting medium | Information  |
|-------------------|--|
| Internet          | The Waters Web site includes contact information for Waters locations worldwide. Visit <a href="http://www.waters.com">www.waters.com</a> , and click Waters Division > Contact Waters Online. |
| Telephone and fax | From the USA or Canada, phone 800 252-HPLC, or fax 508 872 1990.<br>For other locations worldwide, phone and fax numbers appear in the Waters Web site.  |
| Conventional mail | Waters Corporation<br>34 Maple Street<br>Milford, MA 01757<br>USA  |

## Safety considerations

---

Some reagents and samples used with Waters instruments and devices can pose chemical, biological, and radiological hazards. You must know the potentially hazardous effects of all substances you work with. Always follow Good Laboratory Practice, and consult your organization's safety representative for guidance.

When you develop methods, follow the "Protocol for the Adoption of Analytical Methods in the Clinical Chemistry Laboratory," *American Journal of Medical Technology*, 44, 1, pages 30–37 (1978). This protocol addresses good operating procedures and the techniques necessary to validate system and method performance.

## Safety considerations specific to the detector

### Radiation hazard

The device does not emit any type of hazardous radiation. It emits a minimum amount of electromagnetic radiation that is within the limits of applicable emissions standards (EN61326).

### Protective grounding

The detector requires protective grounding for operation. The three-conductor electrical cord that supplies power also grounds the device. This power cord is approved by a Nationally Recognized Testing Laboratory (UL, ETL). It must comprise three, 18-gauge, insulated conductors and be rated for 300 V.

### Draining

A drainage system is installed in the detector. There is a drip tray inside the unit to catch any fluid from leaks or spills. This tray is connected to an external drain on the bottom of the device. Tubing connected to this drain routes the fluid into an appropriate waste container.

### Hazardous waste

During standard operation, this device does not produce any by products or waste. Any waste resulting from a leak or spill is channeled into the drain located on the underside of the device. Tubing connected to this drain directs the flow to an appropriate waste container.

### Equipment repair or disposal

Direct questions regarding repair or disposal to Waters at the address and telephone number given on [page i-v](#). Waters carries out equipment disposal in Europe according to the WEEE directive specific to the country. Waters also accommodates any special requirements for locations outside of Europe.

## Safety advisories



Consult [Appendix A](#) for a comprehensive list of warning and caution advisories.

## Operating this instrument

---

When operating the Waters 2414 Reflective Index Detector, follow standard quality-control (QC) procedures and the guidelines presented in this section.

### Applicable symbols

| Symbol   | Definition  |
|--|---|
|                     | Confirms that a manufactured product complies with all applicable European Community directives |
|  ABN 49 065 444 751 | Australia C-Tick EMC Compliant  |

### Audience and purpose

This guide is intended for use by individuals who need to install, operate, maintain, and/or troubleshoot the Waters 2414 Reflective Index Detector.

This guide sets forth procedures for unpacking, installing, using, maintaining, and troubleshooting the Waters 2414 Reflective Index Detector. It also includes appendices for safety warnings and specifications.

### Intended use of the Waters 2414 Refractive Index Detector

The 2414 Refractive Index (RI) Detector is designed for high-performance liquid chromatography (HPLC) applications. It provides sensitivity, stability, and reproducibility for the analysis of components with limited or no UV absorption.

### Calibrating

To calibrate LC systems, follow acceptable calibration methods using at least five standards to generate a standard curve. The concentration range for standards must include the entire range of QC samples, typical specimens, and atypical specimens.

## Quality-control

Routinely run three QC samples that represent subnormal, normal, and above-normal levels of a compound. Ensure that QC sample results fall within an acceptable range, and evaluate precision from day to day and run to run. Data collected when QC samples are out of range might not be valid. Do not report these data until you are certain that the instrument performs satisfactorily.

When analyzing samples from a complex matrix such as soil, tissue, serum/plasma, whole blood, and other sources, note that the matrix components can adversely affect LC/MS results, enhancing or suppressing ionization. To minimize these matrix effects, Waters recommends you adopt the following measures:

- Prior to the instrumental analysis, use appropriate sample pretreatment such as protein precipitation, liquid/liquid extraction (LLE), or solid phase extraction (SPE) to remove matrix interferences.
- Whenever possible, verify method accuracy and precision using matrix-matched calibrators and QC samples.
- Use one or more internal standard compounds, preferably isotopically labeled analytes.

## ISM classification

---

### **ISM Classification: ISM Group 1 Class B**

This classification has been assigned in accordance with CISPR 11 Industrial Scientific and Medical, (ISM) instruments requirements. Group 1 products apply to intentionally generated and/or used conductively coupled radio-frequency energy that is necessary for the internal functioning of the equipment. Class B products are suitable for use in both commercial and residential locations and can be directly connected to a low voltage, power-supply network.



# Table of Contents

---

|  |               |
|--|---------------|
| <b>Copyright notice</b> .....                                  | <b>iii</b>    |
| <b>Trademarks</b> .....  | <b>iii</b>    |
| <b>Customer comments</b> .....                                 | <b>iv</b>     |
| <b>Contacting Waters</b> .....                                 | <b>v</b>      |
| <b>Safety considerations</b> .....                             | <b>v</b>      |
| Safety considerations specific to the detector.....            | vi            |
| Safety advisories .....  | vi            |
| <b>Operating this instrument</b> .....                         | <b>vii</b>    |
| Applicable symbols .....                                       | vii           |
| Audience and purpose.....                                      | vii           |
| Intended use of the Waters 2414 Refractive Index Detector..... | vii           |
| Calibrating .....  | vii           |
| Quality-control .....  | viii          |
| <b>ISM classification</b> .....                                | <b>i-viii</b> |
| <b>1 Introduction</b> .....                                    | <b>1-1</b>    |
| <b>Use of refractive index detectors</b> .....                 | <b>1-2</b>    |
| <b>Operating principles</b> .....                              | <b>1-2</b>    |
| Optical refraction.....  | 1-2           |
| Differential refractometry .....                               | 1-7           |
| Common RI detection problems .....                             | 1-10          |
| <b>Detector description</b> .....                              | <b>1-11</b>   |
| Range and attenuation .....                                    | 1-11          |
| Features.....  | 1-11          |
| Operation modes .....  | 1-13          |
| Flow path.....   | 1-15          |
| Fluid path components .....                                    | 1-18          |
| Optics.....  | 1-21          |

|   |             |
|---|-------------|
| Electronics.....  | 1-22        |
| Temperature control.....  | 1-24        |
| Startup diagnostics tests.....  | 1-25        |
| 2414 Bootloader program.....  | 1-25        |
| <b>2 Installing the Detector .....</b>  | <b>2-1</b>  |
| <b>Dimensions .....</b>   | <b>2-2</b>  |
| <b>Site selection and power requirements .....</b>  | <b>2-2</b>  |
| Site selection requirements.....  | 2-3         |
| Power requirements.....   | 2-3         |
| <b>Unpacking and inspection .....</b>   | <b>2-4</b>  |
| <b>Connecting to the electrical power supply .....</b>                                    | <b>2-5</b>  |
| <b>Connecting tubing and attachments .....</b>  | <b>2-5</b>  |
| Connecting a column or second detector .....  | 2-6         |
| Connecting to waste.....  | 2-7         |
| Connecting to a drip tray.....  | 2-7         |
| Connecting the valve pack drip tray.....  | 2-8         |
| <b>3 Connecting Signal Cables .....</b>   | <b>3-1</b>  |
| <b>Component connection overview .....</b>  | <b>3-2</b>  |
| Supported IEEE-488 and Ethernet configurations.....                                       | 3-3         |
| <b>Ethernet signal cable connections .....</b>  | <b>3-4</b>  |
| Connecting to a Waters data control system via the Ethernet port .....                    | 3-4         |
| <b>IEEE-488 signal cable connections .....</b>  | <b>3-5</b>  |
| Connecting to a Waters data control system via the IEEE-488<br>bus interface.....         | 3-5         |
| Connecting to a Waters PowerLine system controller via the IEEE-488 bus<br>interface..... | 3-7         |
| Setting the IEEE-488 address.....   | 3-8         |
| Making inject start signal cable connections .....  | 3-8         |
| Connecting to a manual injector .....   | 3-10        |
| <b>Analog-out/event-in (I/O) connections .....</b>  | <b>3-10</b> |
| Connecting to a standalone Alliance Separations Module .....                              | 3-12        |

|   |             |
|---|-------------|
| Connecting to the Waters 746 Data Module .....                | 3-16        |
| Connecting to a chart recorder.....                           | 3-17        |
| Connecting to a data control system using analog signals..... | 3-18        |
| Connecting injection trigger signals .....                    | 3-19        |
| Polarity connections.....                                     | 3-22        |
| <b>    Connecting to an external column heater .....</b>      | <b>3-23</b> |
| <b>4 Preparing Solvents .....</b>                             | <b>4-1</b>  |
| <b>Common solvent problems .....</b>                          | <b>4-2</b>  |
| <b>Selecting a solvent .....</b>                              | <b>4-2</b>  |
| Solvent quality .....   | 4-2         |
| Preparation checklist.....                                    | 4-3         |
| Water .....   | 4-3         |
| Buffers .....   | 4-3         |
| Tetrahydrofuran (THF) .....                                   | 4-3         |
| Refractive indices of common solvents .....                   | 4-3         |
| <b>Solvent degassing .....</b>                                | <b>4-5</b>  |
| Gas solubility .....  | 4-5         |
| Solvent degassing methods .....                               | 4-6         |
| Solvent degassing considerations .....                        | 4-7         |
| <b>5 Operating the Detector .....</b>                         | <b>5-1</b>  |
| <b>Powering-on .....</b>                                      | <b>5-2</b>  |
| Initializing.....   | 5-2         |
| Diagnostics failure at startup .....                          | 5-3         |
| Using Help.....   | 5-3         |
| Using the keypad .....  | 5-3         |
| Navigating the user interface .....                           | 5-9         |
| <b>Operating in RIU mode .....</b>                            | <b>5-10</b> |
| Using the display in RIU mode.....                            | 5-10        |
| Navigating to and from the home screen in RIU mode .....      | 5-13        |
| Setting up a run in RIU mode.....                             | 5-16        |
| Programming timed events, threshold events, and methods.....  | 5-17        |

|   |             |
|---|-------------|
| <b>Operating in 410 (standalone) mode</b> .....                         | <b>5-25</b> |
| Using the display in 410 mode .....                                     | 5-25        |
| Navigating to and from the home screen in 410 mode .....                | 5-27        |
| Setting up a run in 410 mode .....                                      | 5-30        |
| <b>Operating in 410 (remote) mode</b> .....                             | <b>5-30</b> |
| <b>Configuring the detector</b> .....                                   | <b>5-31</b> |
| <b>Optimizing performance</b> .....                                     | <b>5-35</b> |
| Attenuation/sensitivity guidelines .....                                | 5-35        |
| Operating the trace and scale functions .....                           | 5-38        |
| <b>Powering-off</b> .....   | <b>5-39</b> |
| Removing buffered mobile phase .....                                    | 5-39        |
| <b>6 Maintenance Procedures</b> .....                                   | <b>6-1</b>  |
| <b>Decontaminating the fluid path</b> .....                             | <b>6-2</b>  |
| <b>Replacing fuses</b> .....  | <b>6-4</b>  |
| Identifying a faulty fuse .....   | 6-4         |
| <b>7 Error Messages, Diagnostic Functions, and Troubleshooting</b> .... | <b>7-1</b>  |
| <b>Error messages</b> .....   | <b>7-2</b>  |
| Startup error messages .....  | 7-2         |
| Operational error messages .....  | 7-3         |
| <b>Performing diagnostic functions</b> .....                            | <b>7-6</b>  |
| Accessing the diagnostic functions .....                                | 7-6         |
| Using the Optimize LED diagnostic function .....                        | 7-9         |
| Using the input and output diagnostic functions .....                   | 7-9         |
| Display and keypad diagnostic tests .....                               | 7-11        |
| Using the Other diagnostic functions .....                              | 7-12        |
| <b>Troubleshooting</b> .....  | <b>7-14</b> |
| Hardware troubleshooting .....  | 7-15        |
| Chromatography troubleshooting .....                                    | 7-16        |
| Poor peak resolution .....  | 7-23        |
| Incorrect qualitative/quantitative results .....                        | 7-25        |

|   |             |
|---|-------------|
| <b>A Safety Advisories .....</b>  | <b>A-1</b>  |
| <b>Warning symbols .....</b>  | <b>A-2</b>  |
| Task-specific hazard warnings.....  | A-2         |
| Warnings that apply to particular instruments, instrument components, and sample types..... | A-3         |
| <b>Caution symbol .....</b>   | <b>A-4</b>  |
| <b>Warnings that apply to all Waters instruments .....</b>                                  | <b>A-4</b>  |
| <b>Electrical and handling symbols .....</b>  | <b>A-11</b> |
| Electrical symbols .....  | A-11        |
| Handling symbols .....  | A-12        |
| <b>B Specifications .....</b>   | <b>B-1</b>  |
| <b>2414 refractive index detector specifications .....</b>                                  | <b>B-1</b>  |



# 1 Introduction

## Contents

| Topic                             | Page |
|-----------------------------------|------|
| Use of refractive index detectors | 1-2  |
| Operating principles              | 1-2  |
| Detector description              | 1-11 |

## Use of refractive index detectors

---

The major advantage of refractive index detectors lies in the universal nature of their response. They are well-suited to analyze compounds that are without strong UV chromophores, fluorophores, or electrochemical or ionic activity. RI detectors are used to analyze carbohydrates and lipids and in polymer analyses by gel-permeation or size-exclusion chromatography.

RI detectors work by measuring changes in the bulk properties of the solvent and the solutes under investigation, exploiting the improbability that solvents and solutes would share the identical refractive index.

RI detection is inherently less sensitive than other detection methods. It is not suitable to gradient analyses, and changes in solvent temperature and pressure can cause baseline instability. Also, the possibility exists that positive or negative peaks can appear during a single analysis.

## Operating principles

---

### Optical refraction

When a beam of light passes from one medium into another, it changes its speed. If the light enters the second medium at an angle that is not perpendicular to the medium's surface, the light is bent (refracted).

The extent to which a medium refracts light is its refractive index (RI), calculated as the ratio of the velocity of light in a vacuum to the velocity of light in the medium. It is a physical property of the medium, with a dimensionless integer value represented by the letter  $n$ .

This section addresses:

- factors that affect RI
- measuring refraction
- using changes in RI for sample detection

### Factors that affect RI

The refractive index of a medium depends solely on the speed of light through the medium, which is constant for a given wavelength of light at a specified temperature and pressure.



## Wavelength

The refractive index of a medium has a specific value that changes with the wavelength of the incident light beam. The 2414 refractive index detector uses monochromatic light at a fixed wavelength, so the effect of different wavelengths of light on RI is not discussed in this guide.

## Density

The density of the medium also affects its RI. At a fixed wavelength, the relationship between the density of a medium and its RI is generally, but not necessarily, linear. The most important of the factors that affect the density of a medium are:

- composition
- temperature
- pressure

The following figure illustrates the effect of density on the RI of two solutions. The refractive index of a sucrose solution changes linearly with concentration over this range of compositions, but a methanol solution exhibits a nonlinear region between concentrations of 45 and 55%.

## Effect of density on RI

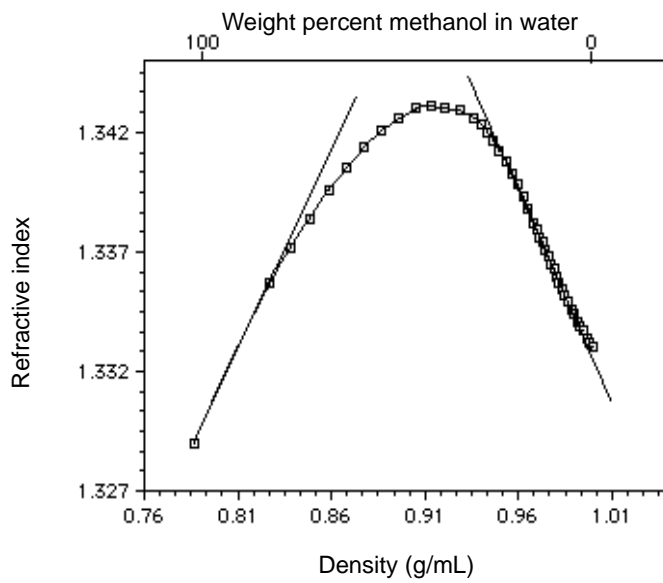
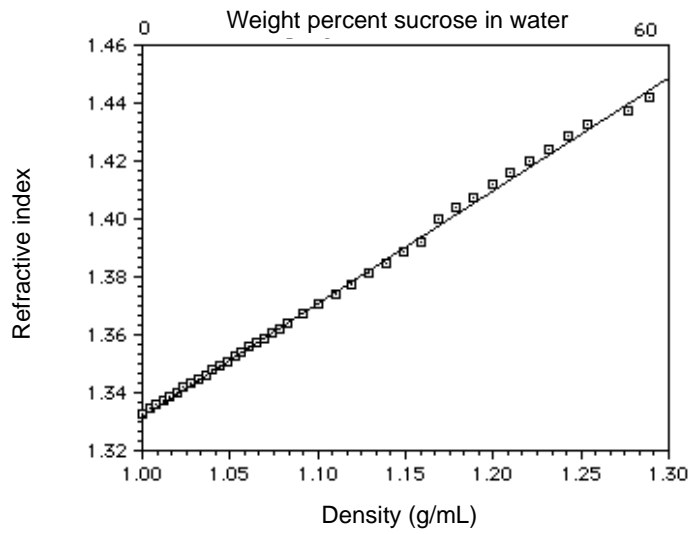

## Measuring refraction

The extent to which a beam of light is refracted when it enters a medium depends on these properties:

- Angle at which the light enters the new medium (the angle of incidence)
- Refractive indices of the old and new media

The angle of a refracted light beam through the new medium is its angle of refraction.

The following figure illustrates the relationship between angle of incidence, angle of refraction, and refractive index.

## Refraction of light

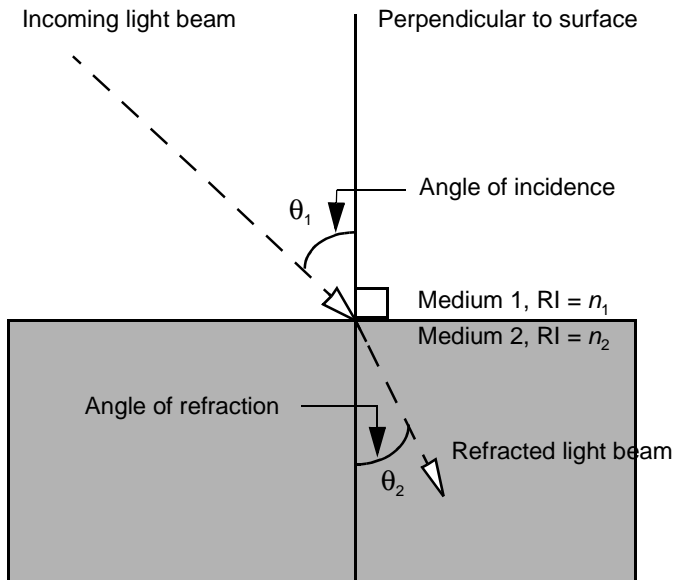

The relationship between the refractive indices of the two media and the angles of incidence and refraction is described by Snell's Law:

$$n_1(\sin \theta_1) = n_2(\sin \theta_2)$$

where:

$$\theta_1 = \text{Angle of incidence}$$

$\theta_2$  = Angle of refraction

$n_1$  = RI of medium 1

$n_2$  = RI of medium 2

You can use Snell's Law to calculate the RI of a sample solution from the angle of incidence, the RI of the solvent, and the angle of refraction.

### Using changes in RI for sample detection

As the separated components of a sample pass through the refractometer flow cell:

- The composition of the sample solution in the flow cell changes.
- The RI of the solution changes.
- The light beam passing through the solution is refracted.

The refractometer detects the position of the refracted light beam, creating a signal that differs from the baseline signal.

The following figure shows how refraction by the sample in the flow cell changes the proportion of light on each element of the photodiode.

## Presence of sample changes the photodiode signal

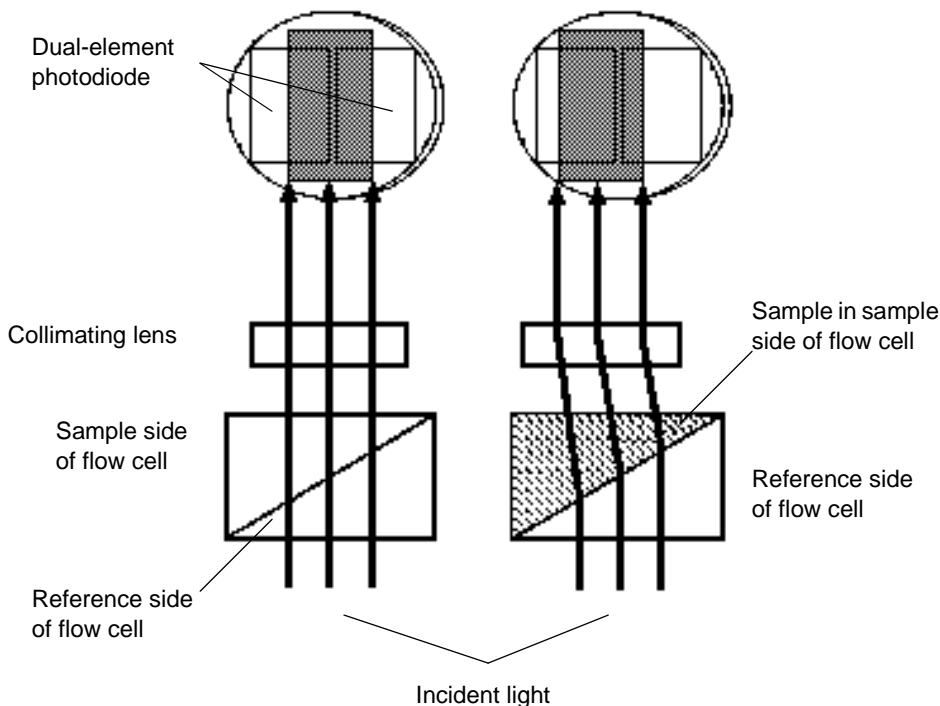

By keeping wavelength, temperature, and pressure constant, the changes in RI measured by the refractometer are due only to changing sample concentration. A solution with a high concentration of a solute refracts a beam of light more than a dilute solution. Therefore, high concentrations of sample yield large peaks.

## Differential refractometry

The 2414 refractive index detector can measure extremely small changes in refractive index to detect the presence of sample. The small difference in RI between a reference solution and a sample solution is referred to as  $\Delta n$ .  $\Delta n$  is expressed in refractive index units (RIU).

The 2414 refractive index detector measures  $\Delta n$  values as small as  $7 \times 10^{-9}$  RIU by detecting the difference in the amount of light falling upon each of the elements of the dual-element photodiode (see the figure, above).

## External angle of deflection

The amount of light falling upon the elements of the photodiode is determined by the external angle of deflection ( $\phi$ ), as shown in the figure, below. The  $\phi$  determines the magnitude of the shift ( $\Delta x$ ) of the image cast on the photodiode by the light beam.

The following figure illustrates the external angle of deflection ( $\phi$ ) and its dependence on the difference in RIs between the reference and sample sides of the flow cell.

## How refraction changes the external angle of deflection

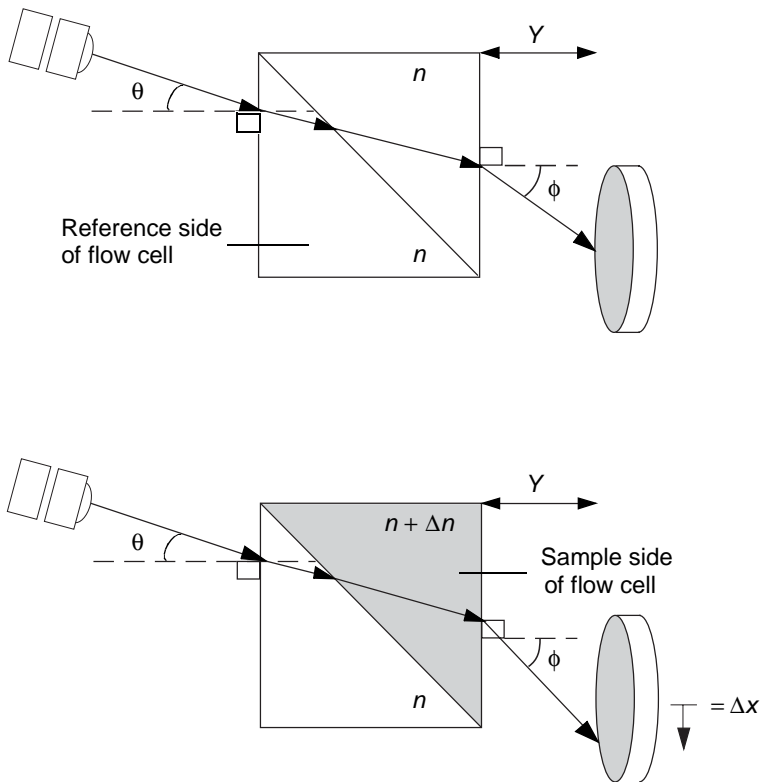

## Effect of refraction on $\phi$

As the beam of light moves along the light path to the photodiode, it encounters and is refracted by the air in the optics bench assembly, the fused

quartz walls of the flow cell, the solvent in the reference side of the flow cell, and the solution in the sample side of the flow cell.

Of these refractors, only the solution in the sample side of the flow cell changes over the course of a run. As a result, the reference external angle of deflection ( $\phi$ ) does not change until a change in the RI of the sample causes the light beam to be refracted from its zero position.

The relationship between the external angle of deflection ( $\phi$ ) and the RI of the sample solution is expressed as:

$$\Delta n \cong \phi / \tan \theta$$

where:

$\Delta n$  = Difference in RI between the solvent and the solvent-sample solution

$\phi$  = External angle of deflection (in radians)

$\theta$  = Angle of incidence (in radians)

### Effect of refraction on the photodiode signal

The change in  $\phi$  determines the shift ( $\Delta x$ ) of the light beam on the photodiode. Because the 2414 detector uses a dual-pass optics bench assembly, the light beam passes through the flow cell twice before reaching the photodiode, doubling the image shift.

The relationship between the image shift ( $\Delta x$ ) at the 2414 detector photodiode and the change in RI of the solution is expressed as:

$$\Delta x = 2 Y(\tan \theta) \Delta n$$

where:

$\Delta x$  = Distance of the image shift at the photodiode

$Y$  = Distance from the flow cell to the photodiode

$\theta$  = Angle of incidence

$\Delta n$  = Difference in RI between solvent and sample solution

The angle of incidence ( $\theta$ ) and the distance to the photodiode ( $Y$ ) are fixed in the refractometer, so the equation becomes

$$\Delta x = C \Delta n$$

where

$C$  = A constant representing the fixed values

By detecting how far the image shifts ( $\Delta x$ ), the refractometer measures the difference in RI ( $\Delta n$ ) between the solvent-sample solution and the solvent alone.

The shift in the amount of the light beam striking each element of the dual-element photodiode results in a change in the output voltage from the 2414 detector. The integrator or chart recorder registers the changes in output voltage as peaks in your chromatogram.

## Common RI detection problems

Changes in solution density caused by factors other than sample concentration are the most common source of problems in RI detection. Changes in solution density can be due to these causes:

- Environmental factors such as changes in temperature or pressure
- Inhomogeneities in the solution

### Environmental factors

Even small changes in ambient temperature can cause baseline drift. Backpressure pulses from a dripping waste tube can cause short-term baseline cycling. Refer to [Chapter 7, “Error Messages, Diagnostic Functions, and Troubleshooting”](#) for more information.

### Inhomogeneities in solution

The differential refractometer measures the difference in refraction between the reference solvent and the sample solution. Most common inhomogeneity problems are due to improper solvent preparation.

- The mobile phase must be of constant composition.
- Gradient separations are not recommended since the  $\Delta n$  from the mobile phase change is larger than that from the analyte peak.

Because the 2414 detector is sensitive to contaminants, replacing tubing can often require long wash times. See [Chapter 4, “Preparing Solvents”](#) for more information.



## Detector description

---

The detector is designed for high-performance liquid chromatography applications. It can operate as a standalone unit with an integrator or chart recorder, or with a Waters system controller or Waters data system.

Refer to [Chapter B, “Specifications”](#) for system specifications, and to [Chapter 4, “Preparing Solvents”](#) for solvent considerations.

### Waters 2414 Refractive Index Detector

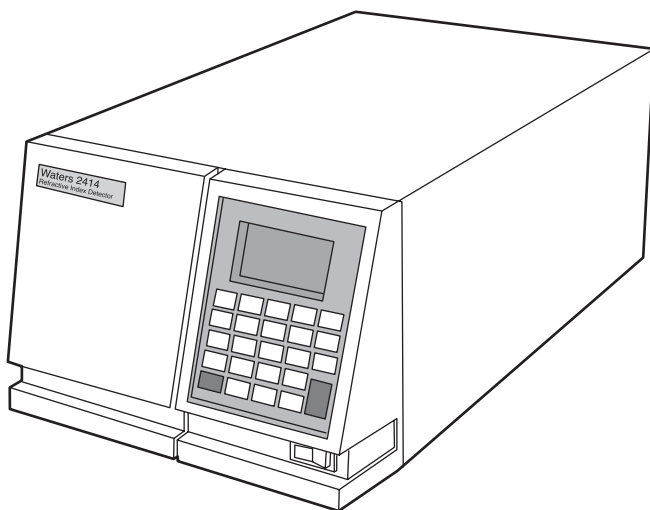

### Range and attenuation

The detector functions with solvents with refractive indices between 1.00 and 1.75. The measurement range of the instrument is  $7 \times 10^{-9}$  to  $5 \times 10^{-4}$  refractive index units full scale (RIU-FS mode).

### Features

The detector has these key features:

- Standalone programmability – Stores up to 10 user-defined programs (or methods) consisting of up to 16, programmable, timed events and 1 threshold event (in standalone RIU mode).

- Single channel/additional channel to monitor temperature – Monitors refractive index and either the detector oven or column heater module temperatures.
- Full diagnostic capability – Supports built-in diagnostic tools to optimize functionality and performance.
- Thermal stability – The 2414 detector uses a countercurrent heat exchanger design and temperature-controlled cell for stable operation and fast warmup and reequilibration times.
- Ethernet support – Allows the 2414 detector to operate as a component of an HPLC system controlled by a data control system, such as Empower 2, using Ethernet communications.
- IEEE-488 support – Allows the 2414 detector to operate as a component of an HPLC system controlled by Empower™, Millennium®<sup>32</sup>, or MassLynx™ software or an Alliance separations module using IEEE-488 communications.
- Single, programmable contact closure output – The 2414 detector has a configurable switch, which can accommodate a maximum +30 V and 1 A. The switch (SW1) can trigger fraction collectors and other external devices, as well as activate based on time and refractive index threshold criteria.
- Refractive index units – In standalone RIU mode, the 2414 detector provides measured refractive index signals to nano-RIU sensitivity
- Purge mode – Before performing a measurement, the 2414 detector can be programmed automatically or by using the front panel keypad to purge the reference flow cell.
- Programmable auto zero – At the beginning of an injection, the 2414 detector can be programmed to auto zero the signal output immediately or after a programmable time delay of up to 30 seconds.
- Column heater module control – The 2414 detector can control a single Waters column heater or column heater cooler module.
- Long-life LED – The 2414 detector is equipped with an 880-nm, long-life LED.
- Recycle valve – A preconfigured diverter valve used to recycle solvent during equilibration to reduce solvent consumption.

## Operation modes

The 2414 detector operates as a single-channel detector, but can be configured to operate in one of two modes to acquire refractive index signal data: RIU mode and 410 emulation mode. Additionally, the detector can monitor temperature as an auxiliary channel.

### RIU mode

RIU mode is the default, standalone operating mode for the 2414 detector which monitors a single channel using micro-refractive index units ( $\mu$ RIUs). Note, however, that RIU mode is not compatible with legacy data systems or controllers.

Methods and timed event programming are available only when the detector is configured in RIU mode.

You can configure several additional parameters when using the detector in RIU mode:

- Attenuation in RIU-FS (comparable to the Sensitivity parameter in 410 mode) – Where the analog output channel reaches its full value of  $\pm 2$  volts, you can specify a scaling factor in RIU mode for the analog output channel that corresponds to the refractive index value. RIU-FS varies from 1 to 500  $\mu$ RIUs.



**Caution:** Changing the attenuation (RIU-FS) setting affects only the 2-V analog output

- Filter Type – In RIU mode, the filter can be set to the digital Hamming or RC types.
- Filter time constant, in seconds – You can program a filter time in seconds. Selecting a value of 0.0 disables all filtering. The default value is 1.0 seconds.

From the RIU mode home screen, pressing Next brings you to a fourth page of secondary, or less frequently used, parameters:

- Voltage offset, in mV – You can program a voltage offset in millivolts. Only the analog output is affected.
- Micro RIU offset in  $\mu$ RIUs – You can program a  $\mu$ RIU offset. Only the analog output is affected.

- Enable keypad – You can program whether these keypad function keys can be accessed:
  - Purge on keypad/panel active
  - Recycle on keypad/panel active
  - Auto-Zero on inject on keypad/panel active
  - Auto-Zero delay, from 0 to 30 seconds
  - Chart mark on keypad/panel active
  - Auto-Zero on keypad/panel active

### 410 emulation mode

When the 2414 detector is controlled by a data control system such as an Empower workstation, it automatically reconfigures to the 410 mode of operation enabling the detector's backward compatibility features. In 410 mode, the detector monitors a single channel, in millivolts, and does not support standalone method programmability. Control is provided via the data system software or Alliance system. You can configure several additional parameters when using the detector in 410 mode:

- Sensitivity – Used in the scaling of the refractive index data in millivolts and affecting the front panel display, analog outputs, and remote interface data. Sensitivity is used only to generate Waters 2410/410 RI Detector-compatible data for older data systems and controllers.
- Filter type – In 410 mode, the filter is always set to RC.
- Filter time constant, in seconds – You can program a filter time in seconds. Selecting a value of 0.0 disables all filtering. The default value is 1.0 seconds.

From the 410 mode home screen, pressing Next brings you to a fourth page of secondary, or less frequently used, parameters:

- Voltage offset, in millivolts – You can program a voltage offset in millivolts. Only the analog output is affected.
- Enable keypad – You can program whether these keypad function keys can be accessed:
  - Purge on keypad/panel active
  - Recycle on keypad/panel active
  - Auto-Zero on inject on keypad/panel active

- Auto-Zero delay, from 0 to 30 seconds
- Chart mark on keypad/panel active
- Auto-Zero on keypad/panel active

## Flow path

When the 2414 detector is acquiring data, its normal configuration for flow allows mobile phase to pass through the sample flow cell and then to waste or to the recycle valve.

### During analysis, the solvent sample takes the following path

1. Enters through the inlet tubing port.
2. Passes through the inlet tube of the countercurrent heat exchanger.
3. Flows through the end-cap heat exchanger.
4. Flows through the sample side of the flow cell.
5. Exits through the outlet tube of the countercurrent heat exchanger.
6. Passes through the solenoid valve and recycle valve to the waste tubing.

## Flow path during analysis

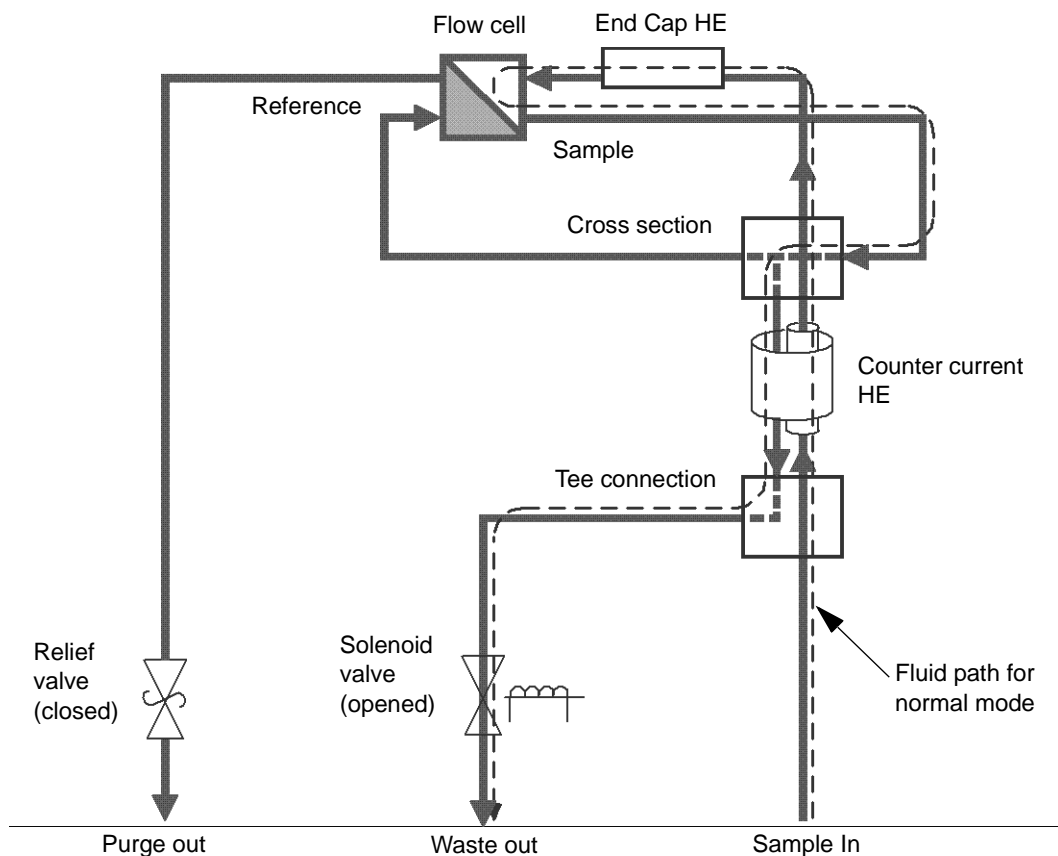

## Purge mode

While in purge mode, fluid passes through the sample side and reference side of the flow cell and exits the “purge out” port. A programmatically controlled solenoid valve determines the fluid path.

**When you purge the 2414 refractive index detector, solvent takes this path**

1. Enters through inlet tubing port.
2. Passes through the sample in tube of the countercurrent heat exchanger.
3. Flows through the end-cap heat exchanger.

4. Flows through the sample side of the flow cell.
5. Flows out to the cross fitting, bypassing the countercurrent heat exchanger.
6. Flows through the reference side of the flow cell.
7. Exits through the pressure relief valve, to the purge outlet tubing port.

### Flow path during purge

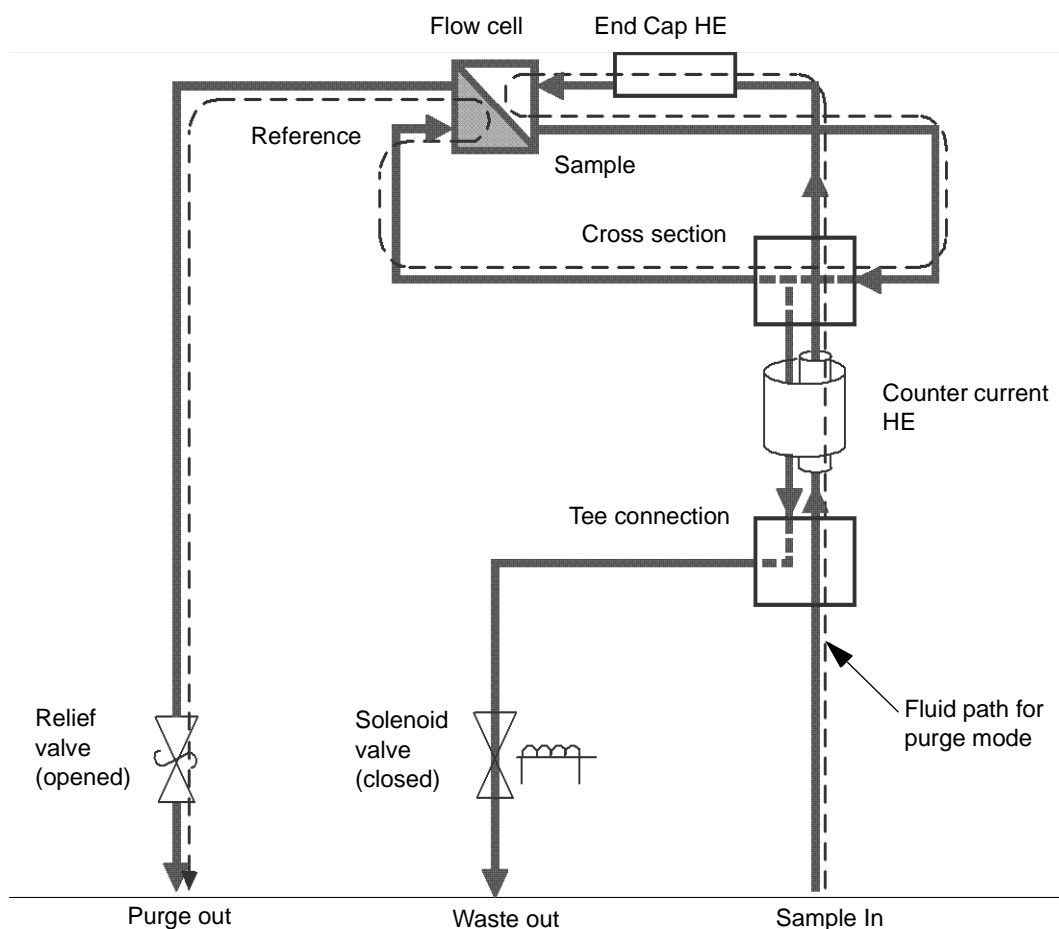

You purge the flow cell before an analysis to pass fresh mobile phase into the reference side of the cell. Therefore, no chromatographically significant data is available during a purge.

An icon in the front panel display and remote interface indicates when the detector is engaged in purge mode.

A purge can be requested from the front panel, rear panel, or remote interface. Under control by a data system or controller, two distinct commands enable the Purge function with one command, and the end of purge with a separate command. Pressing the front panel's Purge key toggles the purge state unless overridden by the purge input signal.

A data system can also request a purge for a duration of time.

## Recycle mode

You engage the recycle mode via the detector's front panel, or remote control interface like a data system or controller. A programmatically controlled recycle (solenoid) valve diverts the outlet fluid to one of two ports. An icon appearing in the front panel display indicates when the unit is in recycle mode. The recycle valve ports and their corresponding outlet lines are labelled accordingly.

A recycle external event input can be triggered to put the 2414 detector into recycle mode. The input puts the detector in recycle mode on each transition, according to how the event is configured. You can also disable the input.

## Fluid path components

The fluid path of the 2414 detector includes these components:

- Countercurrent heat exchanger
- End-cap heat exchanger
- Flow cell, with sample and reference sides
- Solenoid valve
- Pressure relief valve
- Recycle valve
- Inlet and outlet tubing



## 2414 external plumbing and valves

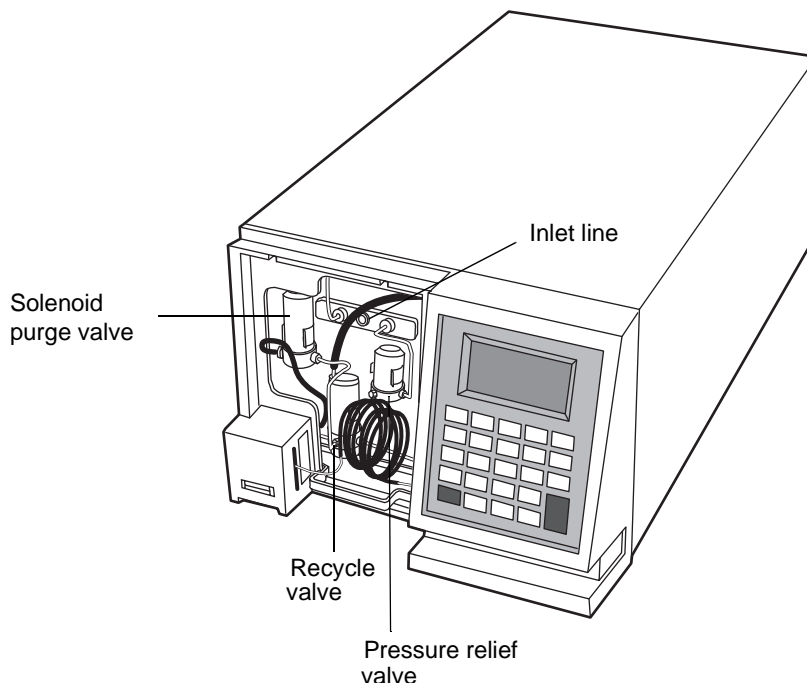

## Countercurrent heat exchanger

The low-dispersion, countercurrent heat exchanger minimizes temperature fluctuations in the sample stream. The device's sample inlet and outlet lines are coaxial, which facilitates heat exchange between incoming and outgoing fluids.

## Flow cell

The flow cell consists of two fused, quartz, hollow prisms. Each cell has an inlet and outlet. One of the prisms constitutes the cell's sample side through which a constant flow of eluent passes during analysis.

The other prism constitutes the cell's reference side. It is filled with fresh solvent when you purge the detector during equilibration. When you switch from purge to normal operation, the solenoid valve opens, and the pressure relief valve shuts, stopping the flow of solvent through the reference prism but leaving the cell filled with solvent.

## Solenoid valve

During normal operation, the solenoid valve remains open. Fluid that passes through the sample side of the flow cell flows through the solenoid valve and out through the outlet tubing (blue) to the waste reservoir.

When you purge the detector, the solenoid valve closes causing fluid passing through the sample side of the flow cell to flow out through the reference side of the flow cell, through the purge outlet tubing (blue).

## Pressure relief valve

During normal operation, the pressure relief valve remains closed. It opens when the pressure for the flow cell, whose maximum pressure rating is 690kPa (6.9 bar, 100 psi), gets too high to withstand. This protects the flow cell from exceeding the maximum pressure rating. The pressure rating of the relief valve is 103.4 kPa (1 bar, 15 psi).

During purging, fluid moving through the sample and reference sides of the flow cell goes out through the pressure relief valve, to the waste reservoir. The figures on [page 1-16](#) and [page 1-17](#) indicate the paths of solvent and sample in the 2414 refractive index detector during normal operation and during a purge, respectively. The following table provides the inner diameters of the sample and fluid lines.

## Fluid line diameters

| Fluidic line  | Inner diameter (inches) |
|---------------|-------------------------|
| Sample in     | 0.009                   |
| Sample out    | 0.040                   |
| Reference in  | 0.020                   |
| Reference out | 0.040                   |
| Recycle in    | 0.040                   |
| Recycle out   | 0.040                   |

## Recycle valve

During normal operation the recycle valve remains closed. It opens only when you specify recycling from the front panel or by means of a rear panel external event. A closed valve diverts solvent to the second port to which you can plumb fluid lines and thus return mobile phase to the main solvent reservoir.

during equilibration or at other times when the unit is not performing an analysis.

### Insulated sample inlet tubing

To ensure good thermal isolation, use insulated tubing to connect the temperature-controlled column to the detector's sample inlet.

## Optics

The detector's optics bench assembly consists of these components:

- LED source lamp
- LED lens mask
- LED lens
- Flow cell, with sample and reference sides
- Mirror
- Mirror mask
- Collimating lens
- Stray light mask
- Dual-element photodiode

The following figure shows the path of the light beam as it passes through the components in the optics bench assembly.

## Optics bench assembly light path

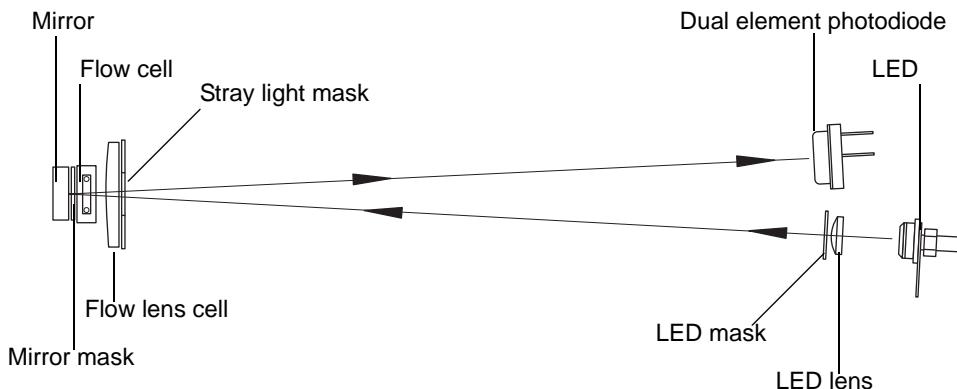

The 2414 detector optics bench directs light as follows:

- Light from the LED is focused by the focusing lens through the aperture and collimating lens, to form a beam.
- The light beam passes through the sample and reference sides of the flow cell to the mirror.
- The light beam is reflected back through both sides of the flow cell and the collimating lens to the dual-element photodiode.

The difference in the amount of light striking the elements of the photodiode (because of sample refraction) results in a deflection from the baseline on the chromatogram.

## Electronics

The 2414 detector has both analog and digital components and includes a front-panel keyboard and these printed circuit (PC) boards and their interconnections:

- CPU board – Contains the digital signal processor, communication ports, nonvolatile (battery backup) RAM, and Flashable RAM space for firmware.
- Personality board – Provides the interface between the analog input signals from the optics and the microprocessor, for further signal conditioning. The board generates analog output signals, drives the LED, Auto Zero, and signal compensation electronics, and stores and

executes input from the front-panel keypad and the rear-panel contact closures. Finally, the personality board provides communication between the 2414 detector and external devices through the Ethernet, IEEE-488 interface, and terminal strip input/output connections.

- Front-panel board – Controls the keypad, indicators, and display.
- Ethernet communications interface – Allows the detector to communicate with a data control system, such as Empower 2, via its Ethernet connector.
- IEEE-488 communications interface – Allows the detector to communicate with the Empower, Millennium<sup>32</sup>, or MassLynx data control system, or Alliance system via its IEEE-488 connector.
- Keypad – Allows you to access the control system, program methods, configure, and troubleshoot the detector.
- DC power supply – Provides voltage for the analog and digital circuitry. It is the DC power source for the detector.

## Filtering noise

The 2414 detector uses a Hamming filter and RC filter to minimize noise:

- Hamming filter – A digital finite impulse response filter, which creates the same amount of peak height attenuation as the RC filter, but enhances the filtering of high frequency noise. This filter is available as the default setting RIU mode, but is not available in 410 mode.
- RC filter – A finite impulse response filter, which simulates a first-order resistor and capacitor filter. This filter is available in RIU mode and 410 mode. The behavior of the filter depends on the time constant that you select. The filter time constant adjusts the filter response to achieve an optimal signal-to-noise ratio.

Lower time-constant settings:

- Remove less baseline noise
- Produce narrow peaks, with minimal peak distortion and time delay
- Make very small peaks harder to discriminate from baseline noise

Higher time-constant settings:

- Greatly decrease baseline noise
- Shorten and broaden peaks

The default time constant of 1.0 second in Hamming mode is satisfactory for most applications. To calculate an appropriate time (filter) constant for special applications, use the formula:

$$TC = 0.2 * PW$$

where

TC = Time constant (filter) setting

PW = Peak width at half the height of the narrowest peak

## Polarity

Detection peaks can be positive or negative. You must configure and change the polarity of the detector signals while acquiring data. Use the Polarity parameter to invert the sign of the RI data. A positive polarity leaves the data unaffected; a negative polarity essentially multiplies the value of each data point by  $-1$ , inverting the chromatogram. Polarity affects the analog output, front panel display, and remote data system, such as Empower.

Polarity can be set or changed from various places: front-panel key press, remote interface command, rear panel event input (Polarity 1), timed event. Polarity can be thought of as a bimodal state (either positive or negative) that can be changed by an external event trigger.

If an event occurs to change Polarity while Polarity 2 is TRUE, an appropriate error message appears. For instance, a front-panel key press causes a warning message to appear on the front panel display, and a Remote command prompts a warning status.

## Temperature control

The detector oven, which controls the temperature of the flow cell, has a temperature setting range of 30 to 55 °C, in increments of 1 °C, settable to  $\pm 0.1$  °C. The detector oven temperature set point and actual temperature reading is accessible via the front panel's display and the remote interface. The actual reading resolution of the detector oven temperature, on the front panel, is  $\pm 0.5$  °C.

The automatically resettable switch protects the oven temperature from raising above the set point, cutting power to the heater when the thermal limit is exceeded. The switch resets when the oven temperature cools to a safe operating level.

## Column heater module temperature control

The 2414 detector controls an external column heater module through the rear panel's column heater connection. The column heater temperature setting range is 30 to 150 °C, in increments of 1 °C. You monitor the set point temperature and actual temperature reading is accessible via the detector's front-panel display and the remote interface. The actual reading resolution of the column heater module, on the front panel, is 0.1 °C.

## Thermal equilibrium

Waters recommends you allow the 2414 detector to reach thermal equilibrium in as little time as possible from a cold start. Under typical operating conditions the detector reaches equilibrium within a few hours, depending on internal temperature and column temperature.

## Startup diagnostics tests

On startup, the 2414 detector runs a series of automated diagnostic tests. An error message appears if any of the tests fail. These startup diagnostic tests include:

- Central processing unit (CPU)
- Serial communication interface (SCI)
- Electrically erasable programmable read-only memory (EEPROM)
- RAM
- Display test pattern
- Application program checksum verification (2414 code)
- LED verification
- Photodiode
- Purge valve verification

## 2414 Bootloader program

The 2414 Bootloader program is a special type of program that resides permanently in the CPU flash memory. It is responsible for CPU hardware initialization and application-independent communications (such as Ethernet). It is also responsible for starting the detector's software.





# 2

## Installing the Detector

This chapter describes the procedures for selecting the site for installing the detector, unpacking and inspecting the instrument, installing fuses, and connecting plumbing components. For information on connecting the detector to other devices, see [Chapter 3, “Connecting Signal Cables”](#).

### Contents

| Topic   | Page |
|---|------|
| <a href="#">Dimensions</a>                                | 2-2  |
| <a href="#">Site selection and power requirements</a>     | 2-2  |
| <a href="#">Unpacking and inspection</a>                  | 2-4  |
| <a href="#">Connecting to the electrical power supply</a> | 2-5  |
| <a href="#">Connecting tubing and attachments</a>         | 2-5  |

## Dimensions

---

The following figure shows the dimensions of the 2414 refractive index detector.

### Dimensions of the 2414 detector

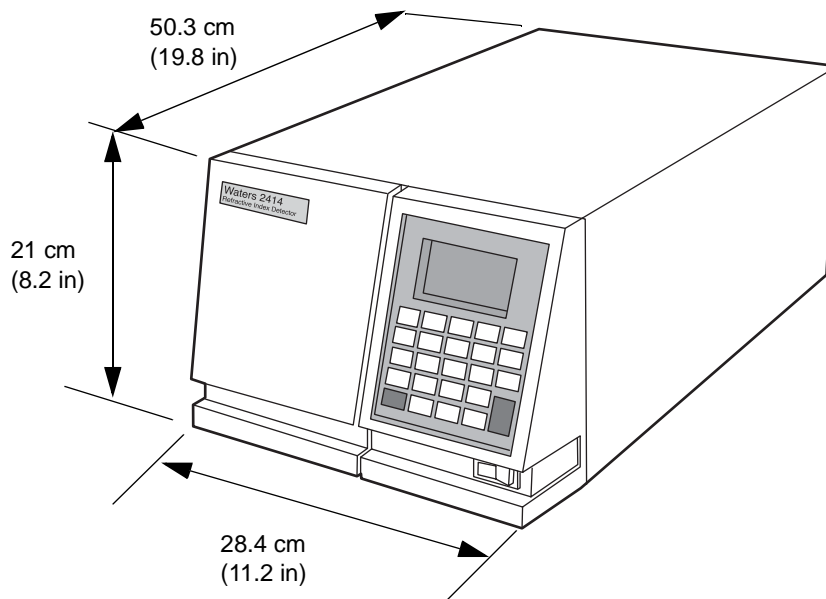

**Warning:** To avoid electric shock, do not access the instrument inside the top cover. All required access is through the front, left-hand panel where the fluid connections are located (see [“Connecting tubing and attachments”](#) on page 2-5).

## Site selection and power requirements

---

Reliable operation of the detector depends on a proper installation site and a suitable power supply.

## Site selection requirements

Install the 2414 detector in an area that meets the requirements listed in the table below.

### Installation site requirements

| Parameter                   | Requirement  |
|-----------------------------|--|
| Operating temperature range | 15 to 40 °C (59 to 104 °F); avoid direct exposure to sunlight and heating and cooling vents.   |
| Storage temperature range   | -40 to 70 °C (-104 to 158 °F)  |
| Relative humidity           | 20 to 80%, noncondensing   |
| Storage humidity range      | 0 to 90%   |
| Bench space                 | At least 28.4 cm (11.2 in.) wide × 63 cm (24.8 in.) deep × 20.8 cm (8.2 in.) high (includes 12.7 cm (5 in.) clearance at rear for ventilation) |
| Static electricity          | <8 kV contact  |
| Power                       | Grounded AC, 100/250 VAC, 50/60 Hz   |
| Surface orientation         | Level (ensures proper drip tray function)  |

## Power requirements

The detector, which operates over the range 100 to 250 VAC, is shipped from the factory with two 3.15 A, 250 V fuses.



**Warning:** To avoid electrical shock, power-off the detector and disconnect the power cord from the rear panel receptacle before you replace a fuse.



**Caution:** To avoid damaging equipment, always replace a fuse with the same type and rating.

The two fuses are located above the power input receptacle, within the power input module on the rear panel.

## Rear panel

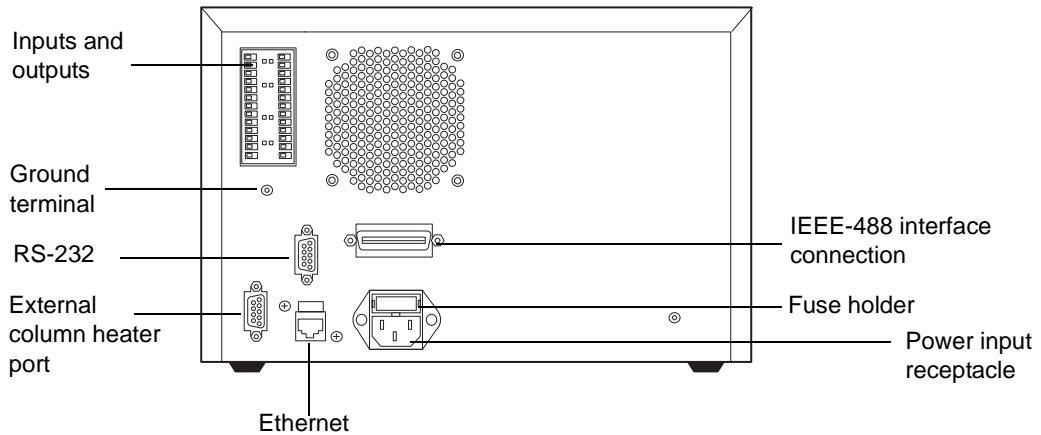

To replace a fuse, see [“Replacing fuses” on page 6-4](#).

## Unpacking and inspection

---

The detector’s shipping carton contains, besides the detector, these things:

- Certificate of structural validation
- Startup kit

When unpacking the detector, check the contents of the shipping carton against the packing list to ensure you received all items.

Report any damage or discrepancy when you inspect the contents of the carton immediately to the shipping agent. U.S. and Canadian customers must contact Waters Technical Service at 800 252-4752. Other customers, may phone their local Waters subsidiary or local Waters Technical Service representative.

**Note:** Make sure the serial number on the detector’s rear panel nameplate or inside the front, left-hand panel matches the number on its validation certificate.

## Connecting to the electrical power supply

---

To connect the 2414 refractive index detector to the AC power supply

1. Plug the receptacle end of the power cord into the AC power input receptacle on the rear panel of the detector (see the figure on [page 2-4](#)).
2. Plug the other end of the power cord into a grounded AC power source.

For information about the remaining rear panel electrical connections, see [Chapter 3, “Connecting Signal Cables”](#).

## Connecting tubing and attachments

---



**Warning:** To avoid chemical hazards, always observe Good Laboratory Practices when handling solvents. Refer to the Material Safety Data Sheets for solvents in use.



**Warning:** To avoid hazards associated with spilled chemicals, ensure waste containers are large enough to accommodate analysis requirements.

This section describes procedures for connecting the detector to these components:

- A column or another detector
- A waste container
- The drip tray

The tubing connections for the detector are on the front panel, behind the front cover and to the left of the keypad.

## Tubing connections

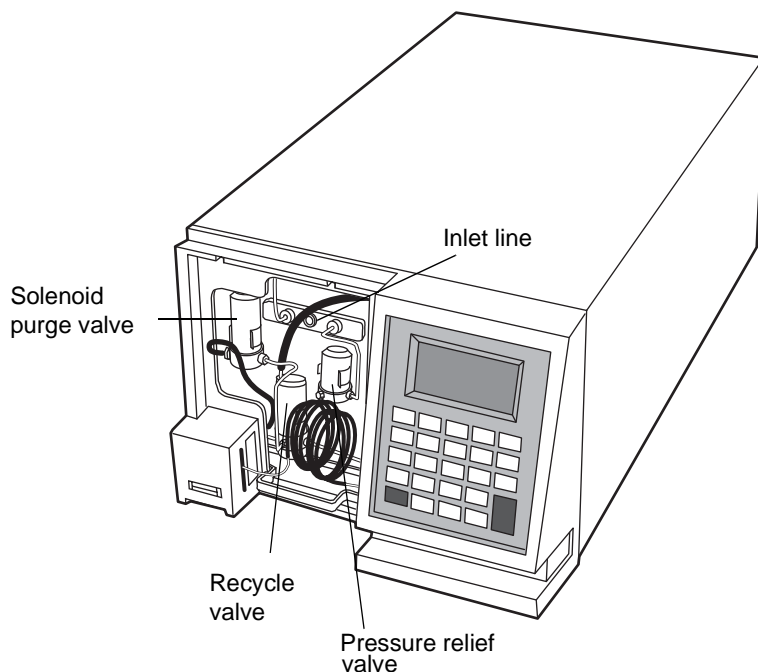

## Connecting a column or second detector

Use only the insulating sample inlet tubing assembly supplied in the startup kit to connect a column or second detector to the detector. This tubing assembly has been prepared with thermal insulation sleeving to moderate the effect of ambient air temperature variations.

**Restriction:** If you are using more than one detector in your system, you must connect the detector as the last detector in line. See [Chapter 3, “Connecting Signal Cables”](#) for information about connecting the detector to the HPLC system via the detector’s signal cable.

### Required materials

- Insulated sample inlet tubing assembly
- Open-end wrench, 5/16-inch

### To connect a column or other detector to the detector

1. Insert one end of the inlet tubing assembly into the inlet port of the index detector.
2. Tighten the compression screw ¼-turn past finger-tight.
3. Repeat step 2, inserting the other end of the inlet tubing assembly into the outlet fitting of the column or another detector.

## Connecting to waste

The detector's flow cell is extremely sensitive to backpressure. Be sure to use the 0.040-inch ID waste tubing supplied, pre-installed, on the detector. Ensure that the solvent waste line does not contact mobile phase waste, thus causing backpressure.

### To connect the detector to waste

1. Place the waste container lower than, or at the same level as, the detector.
2. Uncoil and place the free end of the tubing in the waste container.



**Caution:** The maximum pressure for the detector flow cell is 689.5 kPa (6.89 bar, 100 psi). The flow cell could be damaged if this pressure is exceeded.

## Connecting to a drip tray

A drip tray underneath the flow cell behind the front panel receives solvent leaks and directs the liquid to an outlet at the front of the unit. Be sure to position the waste container below the drip tray outlet.

### Required materials

- Tygon<sup>®</sup> tubing, 3/16-inch ID (from the startup kit)
- Sharp knife

### To connect the drip tray

1. Cut a length of Tygon tubing sufficient to reach between the drip tray and the waste container.

2. Connect the tubing to the white plastic fitting located under the three valves on the front of the detector (see the figure on [page 2-6](#)).
3. Insert the other end of the tubing into the waste container.

## Connecting the valve pack drip tray

A factory-installed drip tray lies beneath the three valves of the valve pack. Be sure to direct the drip tray tube to a suitable waste container.

### Required materials

- Tygon tubing, 3/16-inch ID (from the startup kit)
- Sharp knife

### To connect the drip tray

1. Cut a length of Tygon tubing sufficient to reach between the drip tray and the waste container.
2. Connect the tubing to the white plastic fitting located under the oven of the detector (see the figure on [page 2-6](#)).
3. Insert the other end of the tubing into the waste container.



# 3

## Connecting Signal Cables

This chapter describes procedures for making signal connections between the detector and other HPLC system components.

### Contents

| Topic   | Page |
|---|------|
| <a href="#">Component connection overview</a>           | 3-2  |
| <a href="#">Ethernet signal cable connections</a>       | 3-4  |
| <a href="#">IEEE-488 signal cable connections</a>       | 3-5  |
| <a href="#">Analog-out/event-in (I/O) connections</a>   | 3-10 |
| <a href="#">Connecting to an external column heater</a> | 3-23 |

## Component connection overview

The following table summarizes the signal connections used to connect the detector to the HPLC system components.

### Component connector types

| Connector type | Component   |
|----------------|---|
| Ethernet       | <p>Waters data control system, such as Empower 2, connected via the Ethernet network.</p> <p><b>Tip:</b> The Ethernet port also supports the Waters PC-based Autoloader utility for installing firmware (see the Waters 2414 Refractive Index Detector release notes for details).</p>  |
| IEEE-488       | <p>Any of the following systems:</p> <ul style="list-style-type: none"> <li>• Waters data control system, such as Empower or Millennium<sup>32</sup>, connected via the IEEE-488 bus</li> <li>• Waters Alliance System with separations module functioning as the HPLC system controller, and connected via the IEEE-488 bus (Waters PowerLine™ configuration)</li> </ul> |
| Analog outputs | 746 Data Module (integrator or data system using the A/D interface) Chart Recorder  |
| Event inputs   | <ul style="list-style-type: none"> <li>• System controller (used with the Waters Alliance system and the 600-series solvent delivery system)</li> <li>• Waters 700-series autosampler or an autosampler made by another manufacturer</li> <li>• Waters injector or injector made by another manufacturer</li> </ul>   |
| Ext 1          | One optional external column heater   |
| RS-232         | For firmware upgrades only  |

The following figure shows the rear panel locations of the connectors used to operate the 2414 detector with external devices.

## Rear panel

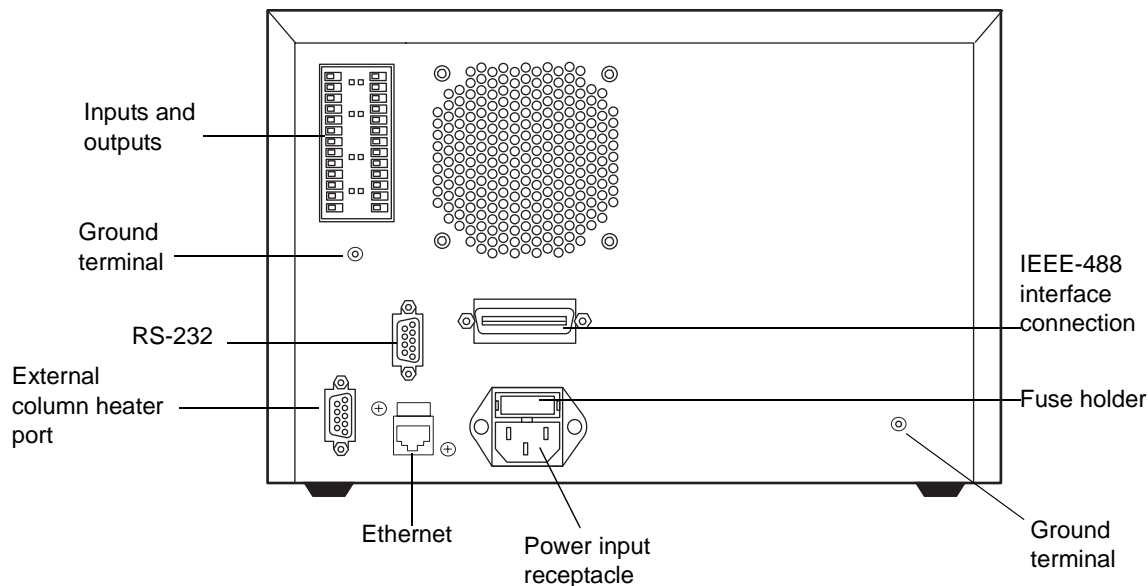

The signal connections you need for your detector communications depend on the signal connections available on the other instruments in your HPLC system. The remainder of this chapter describes the types of available signal connections for the detector.

## Supported IEEE-488 and Ethernet configurations

You can operate a 2414 detector controlled by a data control system in one of these configurations:

- Where all system modules, including the detector, communicate with the data system via an IEEE-488 bus interface
- Where all system modules, including the detector, communicate with the data system via Ethernet communications

## Ethernet signal cable connections

---

You can use its Ethernet port to connect the detector to a Waters data control system, such as Empower 2 software, that supports Ethernet communications.

### HPLC system under Empower 2 software control via Ethernet

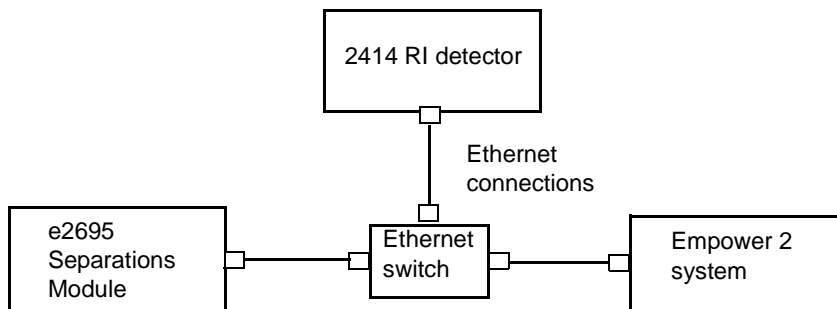

When connected to a Waters data system, the detector is automatically configured to operate in 410 (remote) mode. Using the data control software, you create instrument methods and method sets to control the detector and other HPLC system components. See [Chapter 5, “Operating the Detector”](#) and the data control software documentation for more information on configuring the detector and operating in 410 (remote) mode.

For details on the supported 2414 detector’s software and firmware requirements, see the Waters 2414 Refractive Index Detector release notes.

## Connecting to a Waters data control system via the Ethernet port

The detector is equipped with a RJ-45 connector, for Ethernet port communications (see the figure on [page 3-3](#)). The Ethernet port—a 10/100 Base-T networking interface—is used only for remote control, the case when Empower 2 controls its operation, and for firmware upgrades via the Waters Autoloader utility (see the Waters 2414 Refractive Index Detector release notes).

### Requirements:

- You cannot use the detector’s Ethernet port at the same time you are using its IEEE-488 interface for communications.

- In an Ethernet configuration, all of the Waters HPLC system components, including the 2414 detector, must communicate with the data system via Ethernet communications.
- As with IEEE-488 control, triggering of the inject start signal for the 2414 detector occurs over the Ethernet cable and so requires no external I/O cable. For more information, see [“Making inject start signal cable connections” on page 3-8](#).

For additional Ethernet information, see the *Waters Ethernet Instrument Getting Started Guide* (P/N: 7150074403).

## IEEE-488 signal cable connections

---

You can use the IEEE-488 bus to connect the detector to Waters data systems or Alliance or PowerLine system controllers.

**Restriction:** You cannot use the detector’s IEEE-488 bus interface at the same time you are using its Ethernet port for communications.

### Connecting to a Waters data control system via the IEEE-488 bus interface

You can use the IEEE-488 bus to connect the detector to a Waters data system in any of the following configurations:

- Empower or Millennium<sup>32</sup> system, via the busLAC/E card installed on the computer
- MassLynx system, via the NI IEEE-488 card installed on the computer
- Alliance Separations Module as part of an Alliance HPLC system configuration under Empower or Millennium<sup>32</sup> software control

The following figures show two examples of the cable connections needed to support the these configurations.

### HPLC system, with the detector under Empower software control via the IEEE-488 bus interface

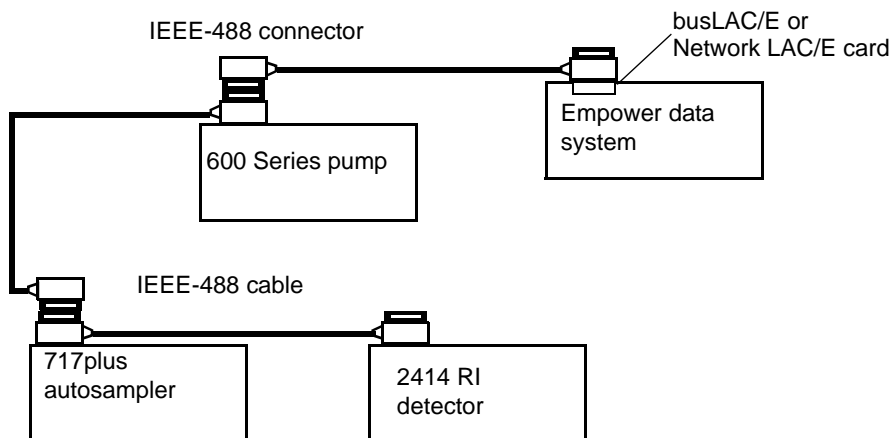

### Alliance HPLC system, with the detector under Empower software control via the IEEE-488 bus interface

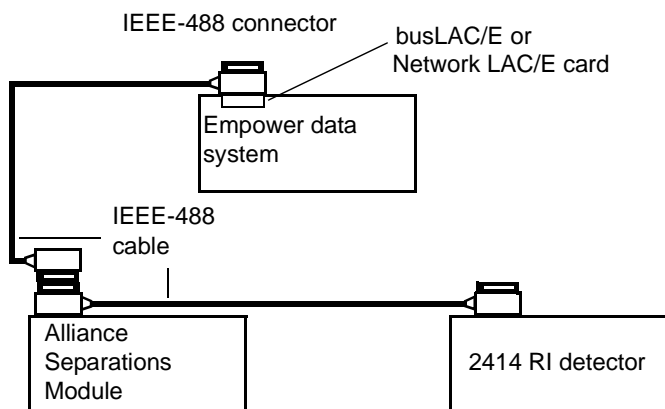

When connected to a Waters data system, the 2414 detector is automatically configured to operate in 410 (remote) mode. You use the data control software to create instrument methods and method sets to control the detector and other HPLC system components. See [Chapter 5, “Operating the Detector”](#) and the data control software documentation for more information on configuring the detector and operating in 410 (remote) mode.

## Connecting to a Waters PowerLine system controller via the IEEE-488 bus interface

The Waters PowerLine system controller is an IEEE-488 configuration in which the Alliance Separations Module or a 600-series solvent delivery system operates as the system controller for the HPLC system components, including the 2414 detector.

To connect the detector to a Waters PowerLine system controller, use the IEEE-488 interface cables as shown in the figure below.

Each fluid-handling unit is configured with either of the following injectors:

- Integrated manual injector (built in as part of the drawer or shelf unit)
- Externally connected manual injector or autosampler

### Waters PowerLine system controller IEEE-488 connections

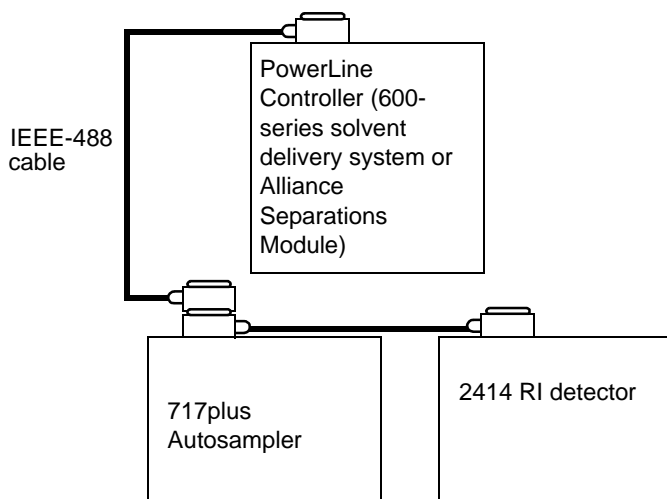

### Requirements:

When an Alliance Separations Module using the IEEE-488 interface controls the detector, these conditions apply:

- The detector is configured in 410 mode (a task you perform via the keypad's "Config" menu).

- The detector automatically changes its configuration to 410 mode when initially configured in RIU mode.
- The keypad locks for 30 seconds following an injection. Afterward, it unlocks until the system sets up for the next injection. (No run clock appears on the screen because the detector is configured in 410 mode.)

## Setting the IEEE-488 address

Like all other IEEE-488 devices, the 2414 detector requires a unique IEEE-488 address to be recognized by an IEEE-488 controller, such as an Empower data system, busLAC/E module, or an Alliance or PowerLine system controller configuration.

The factory-set default IEEE-488 address for the detector is 14.

### To change the IEEE-488 address

1. Press Shift, Config.
2. On the Configuration page, use the arrow keys to locate the IEEE address selector box.
3. Enter the number corresponding to the desired IEEE-488 address, and then press Enter.

**Requirement:** IEEE-488 addresses must be unique for each instrument in an HPLC system, and they must be between 2 and 29. Your HPLC system can require that the IEEE-488 address for the 2414 detector be greater than that for other devices in the system. Consult your data system or controller operator's manual for more information on IEEE-488 communications.

4. To exit the configuration functions, press Home.

## Making inject start signal cable connections

An IEEE-488 data system used with the 2414 detector requires that the data system or controller receive an inject start signal from the autosampler or manual injector to initiate data collection and time-based programs.



**Note:** Depending on your system’s configuration, the inject start signal can be transmitted through the IEEE-488 interface or the analog-out/event-in connectors on the detector’s rear panel. For information on analog-out/event-in connections, see [“Analog-out/event-in \(I/O\) connections” on page 3-10.](#)

The following table summarizes the inject start connections for different system configurations.

**Requirement:** If multiple devices in your system require an inject start signal, connect trigger wires from the same (inject out) terminal on the injector to each device.

#### 2414 RI detector inject start connections

| Inject start output source   | Inject start input connection (on detector connector A)   |
|--|---|
| Waters 715, 717, and 717plus, and Alliance Separations Module, on the IEEE-488 bus | IEEE-488 interface (see <a href="#">“Connecting to a Waters data control system via the IEEE-488 bus interface” on page 3-5</a> ) |
| Waters 715, 717, and 717plus not on the IEEE-488 bus                               | Inject Start +/-  |
| Alliance Separations Module not on the IEEE-488 bus                                | Inject Start +/-  |
| Waters 712 Autosampler   | Inject Start +/-  |
| Waters manual injector, or third-party manual injector or autosampler              | Inject Start +/-  |

For pin-out connections to the detector, see the figure on [page 3-11.](#)

## Connecting to a manual injector

If you are using a manual injector with your IEEE-488 system, connect the signal cables from the detector's rear panel connector to the injector as shown in the table below.

### Waters 2414 connections to a manual injector

| Detector (connector A) | Manual injector                             |
|------------------------|---|
| Inject Start + (red)   | One set of spade-lug Inject Start terminals |
| Inject Start - (black) |   |

For information on injection trigger signals from a manual injector, see [“Connecting injection trigger signals” on page 3-19](#).

## Analog-out/event-in (I/O) connections

---

To connect the detector to instruments not using a digital communications interface (that is, neither Ethernet nor IEEE-488), you use the analog-out/event-in (I/O) connectors on the rear panel.

This section describes signal connections between the 2414 detector's analog-out/event-in connectors and the following components:

- Waters Alliance Separations Module in No Interaction mode
- Waters 746 Integrator
- Chart recorder
- Waters SAT/IN module
- Waters (or other) manual injector
- Other manufacturer's integrator or A/D interface device



**Warning:** To avoid electrical shock, power-off the detector before making any electrical connections.



**Caution:** To meet the regulatory requirements of immunity from external electrical disturbances that can affect the performance of this instrument, do not use cables longer than 9.8 feet (3 meters) when you make connections to the analog-out/event-in connectors. In addition, ensure you always connect the shield of the cable to ground at one instrument only.

The following figure and table describe the two I/O connectors (and their corresponding pin-outs) on the detector's rear panel.

### Rear panel analog-out/event-in connectors

B (inputs and outputs)

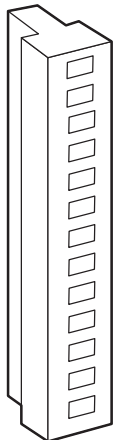

- 1 + Auto Zero
- 2 - Auto Zero
- 3 GROUND
- 4 + Recycle Valve
- 5- Recycle Valve
- 6 + Polarity Enable
- 7 - Polarity Enable
- 8 GROUND
- 9 + Detector Out
- 10 - Detector Out
- 11 GROUND
- 12 + Auxiliary Out
- 13 - Auxiliary Out

A (inputs and outputs)

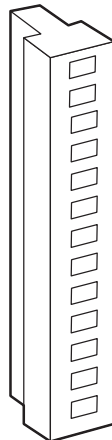

- 1 + Inject Start
- 2 - Inject Start
- 3 GROUND
- 4 + Purge
- 5 - Purge
- 6 + Polarity
- 7 - Polarity
- 8 GROUND
- 9 + Chart Mark
- 10 - Chart Mark
- 11 GROUND
- 12 + Switch
- 13 - Switch

## Waters 2414 analog-out/event-in connections

| Signal Connections  | Description   |
|---|---|
| Chart Mark, Polarity and Polarity Enable, Auto Zero, Purge, Recycle, and Inject Start | Accept TTL-level (0 to +5 V) or contact closure signals from an external instrument   |
| Detector Out  | Sends a $\pm 2$ V (full scale) signal to an integrator or computer                    |
| Auxiliary Out   | Sends a $\pm 2$ V (full scale) signal to an integrator or computer (Temperature Data) |

## Connecting to a standalone Alliance Separations Module

**Requirement:** When you use the Alliance Separations Module as the system controller on the IEEE-488 bus, follow the instructions for connecting to a Waters PowerLine system (see [“Connecting to a Waters PowerLine system controller via the IEEE-488 bus interface”](#) on page 3-7).

When you use the Alliance Separations Module as a standalone controller (that is, not on an Ethernet or IEEE-488 bus interface or under data system control), you can make the following signal connections using the 2414 detector’s analog-out/event-in connectors:

- Auto zero on inject
- Chart mark on inject
- Both chart mark and auto zero on inject
- Inject start

As a standalone controller, the separations module is configured in No Interaction mode, which disconnects the separations module from the Ethernet and IEEE-488 communications interface. (For information on configuring the separations module in No Interaction mode, see the separations module operator’s guide.)

## Generating auto zero on injecting

To generate the auto zero function on the 2414 detector at the start of an injection from the Alliance Separations Module, make the connections shown in the table and figure below.

### Detector connections to an Alliance Separations Module

| Separations module (connector B) | Detector (connector B) |
|----------------------------------|------------------------|
| Pin 1 Inject Start               | Pin 1 Auto Zero +      |
| Pin 2 Inject Start               | Pin 2 Auto Zero -      |

### Auto Zero connections between the Alliance Separations Module and the 2414 detector

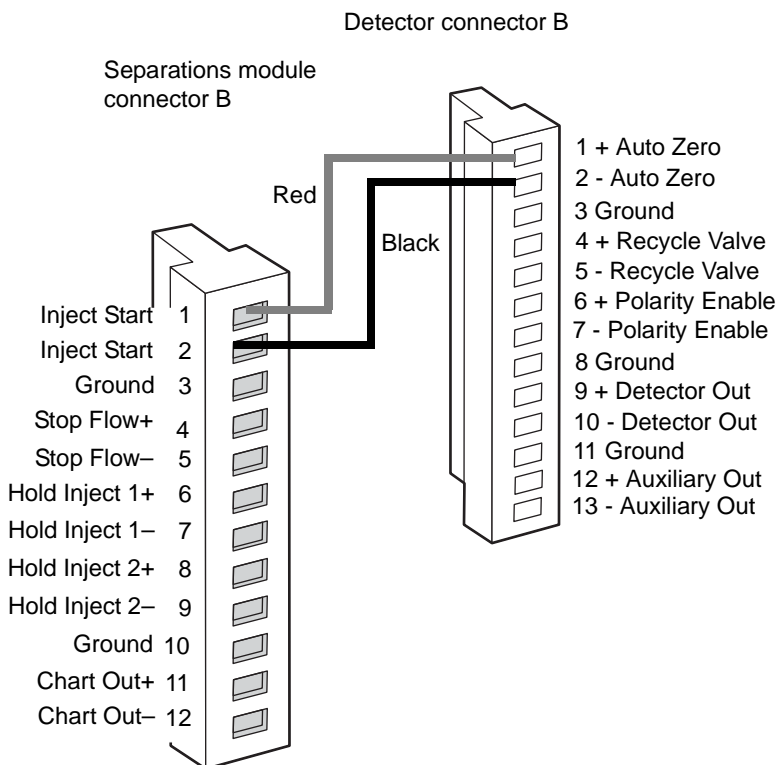

## Generating a chart mark on injecting

To generate the chart mark function on the detector at the start of an injection from the separations module, make the connections shown in the table and figure below.

### 2414 detector connections to a separations module

| Separations module (connector B) | Detector (connector A) |
|----------------------------------|------------------------|
| Pin 1 Inject Start               | Pin 9 Chart Mark +     |
| Pin 2 Inject Start               | Pin 10 Chart Mark -    |

### Chart mark connections between the separations module and the 2414 detector

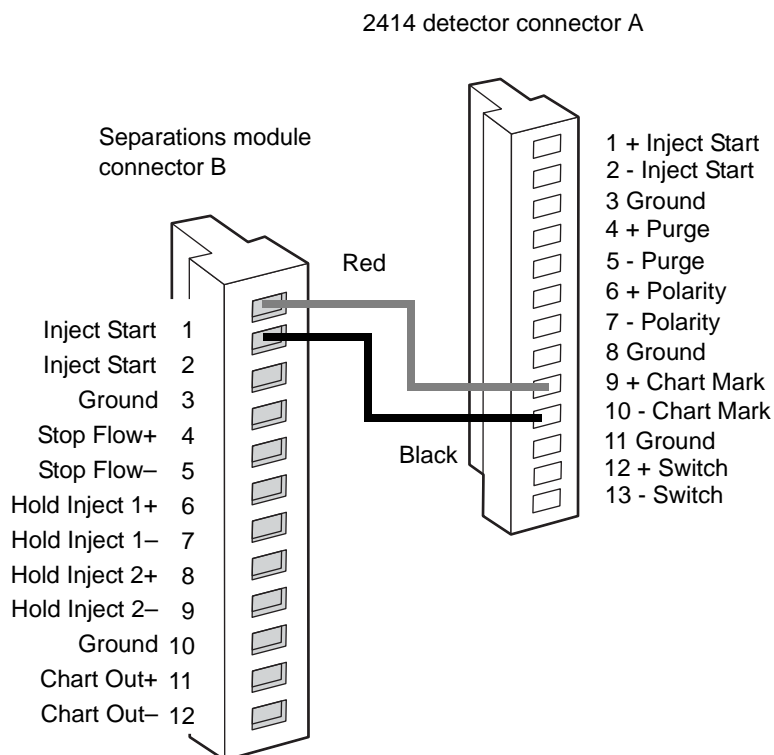

## Generating chart mark and auto zero signals

To generate both a chart mark and an auto zero signal from the separations module to the 2414 detector, make the connections shown in the table and figure below.

### Detector connections to a separations module

| Separations module (connector B) | Detector (connector B) | Detector (connector A) |
|----------------------------------|------------------------|------------------------|
| Pin 1 Inject Start               | Pin 1 Auto Zero +      | Pin 9 Chart Mark +     |
| Pin 2 Inject Start               | Pin 2 Auto Zero -      | Pin 10 Chart Mark -    |

### Chart mark and auto zero connections between the separations module and detector

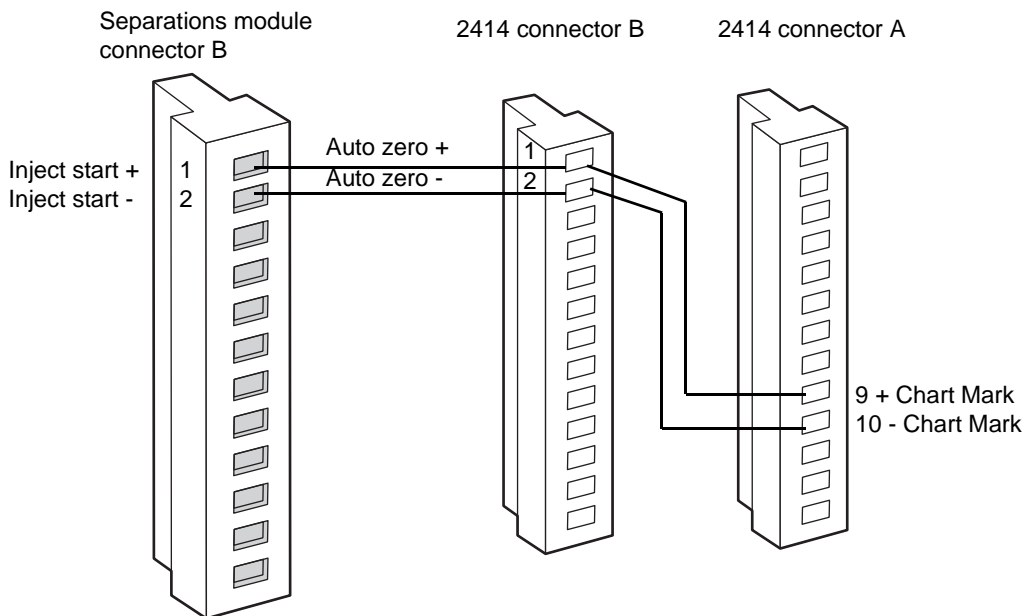

## Connecting to the Waters 746 Data Module

To send an integrator, analog, output signal ( $-2V$  to  $+2V$ ) from the detector to the Waters 746 Data Module, make the connections shown in the table and figure below.

### Analog output connections to a 746 data module

| 746 rear-panel connectors                       | Detector (Connector B)        |
|---|-------------------------------|
| CHA (+)   | Pin 9 Detector Out + (red)    |
| CHA (-)   | Pin 10 Detector Out - (black) |
| Shield not used (tape back to prevent shorting) |                               |

**Note:** If you use another manufacturer's integrator or A/D device, you can possibly need to connect the Chassis Ground (pin 11) to the detector's Detector Out- (black lead) or an equivalent connection.

### Connections to a Waters 746 Data Module

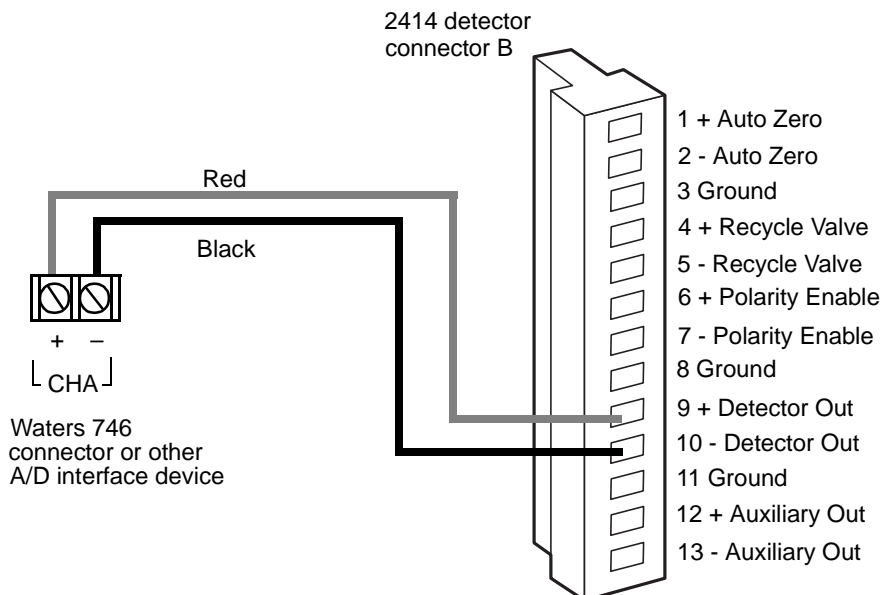



## Connecting to a chart recorder

To send an analog output signal from the 2414 detector to a chart recorder, make the connections shown in the table and figure below.

### Analog output connections to a chart recorder

| Chart recorder connectors                       | Detector (connector B)        |
|---|-------------------------------|
| Pen 1 (+)                                       | Pin 9 Detector Out + (red)    |
| Pen 1 (-)                                       | Pin 10 Detector Out - (black) |
| Shield not used (tape back to prevent shorting) |                               |

### Analog output connections to a chart recorder

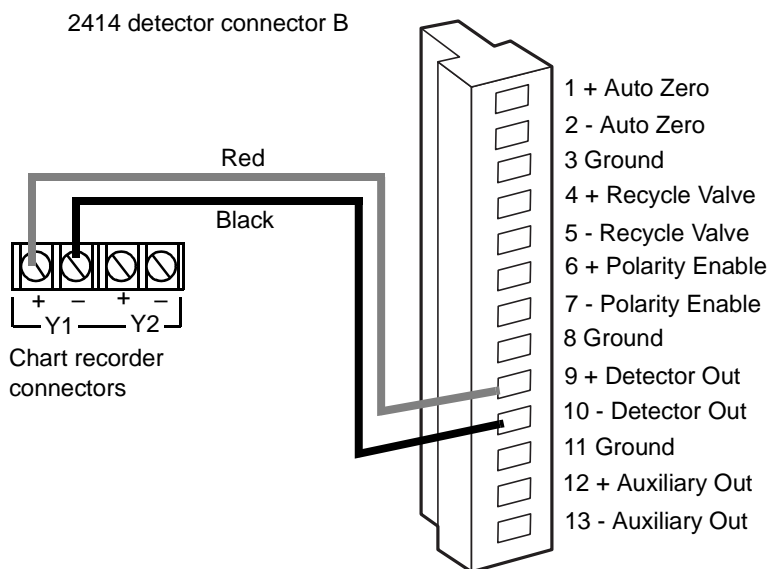

### Performing chart mark with the chart recorder

If you are using the detector with the 746 data module, and you want to send a chart mark pulse to the chart recorder at the start of each run, connect the external device (system controller, autosampler, or manual injector) to the detector's chart mark screw terminals, as described in [“Connecting to the Waters 746 Data Module” on page 3-16](#).

## Connecting to a data control system using analog signals

To send an integrator analog output signal (–2 V to +2 V) from the 2414 detector to an Empower, Millennium<sup>32</sup>, or MassLynx data control system (through a two-channel SAT/IN Module), make the connections shown in the table and figure, below.

**Tip:** The output connections from the detector are the same for busSAT/IN and eSAT/IN modules.

### Analog output connections to the busSAT/IN or eSAT/IN module

| SAT/IN module connector | Detector (connector B)        |
|-------------------------|-------------------------------|
| CHANNEL 1               | Pin 9 Detector Out + (white)  |
|                         | Pin 10 Detector Out – (black) |

## Analog output connections to the SAT/IN module

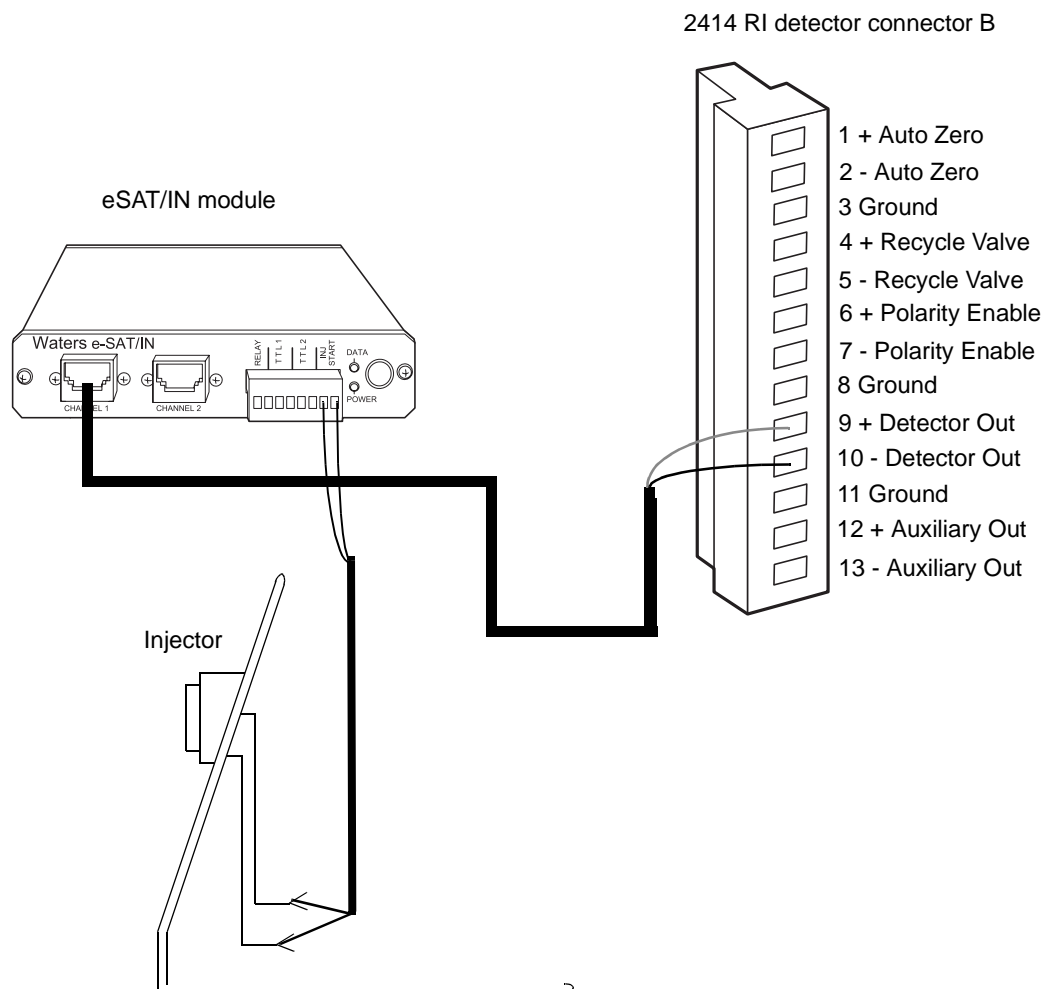

## Connecting injection trigger signals

The 2414 detector accepts the following injection trigger signals from a manual injector:

- Auto-zero signal to automatically adjust the zero offset of the detector each time the injector makes an injection
- Chart mark signal from a contact closure signal with each injection
- Inject start signal from a contact closure signal with each injection

Each time the detector receives a signal from a manual injector, it performs the corresponding auto zero, inject start, or chart mark function.

To send an auto zero or chart mark signal from a manual injector to the detector, make the connections shown in the tables and figures, below.

### Auto zero connections to a manual injector

| Detector (connector B)     | Manual injector connector  |
|----------------------------|--|
| Pin 1, Auto Zero + (red)   | Two spade-lug terminal connectors (both cables can be functionally identical) or similar connectors. |
| Pin 2, Auto Zero - (black) |  |

### Auto zero connection to a manual injector

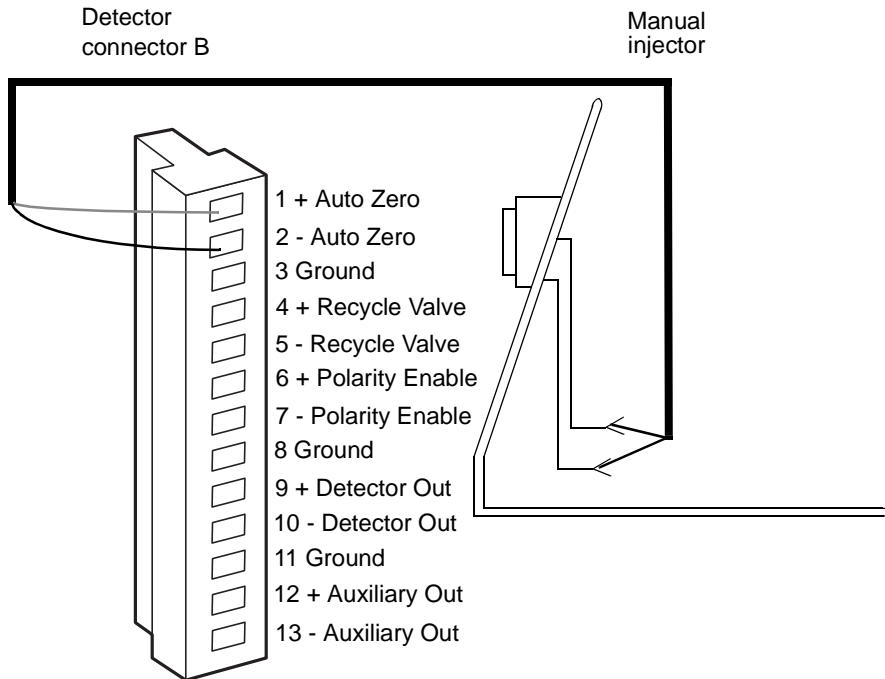

### Chart mark connections to a manual injector

| Detector (connector A)       | Manual injector connector  |
|------------------------------|--|
| Pin 9, Chart Mark + (red)    | Two spade-lug terminal connectors (both cables can be functionally identical) or similar connectors. |
| Pin 10, Chart Mark - (black) |  |

### Chart mark connections to a manual injector

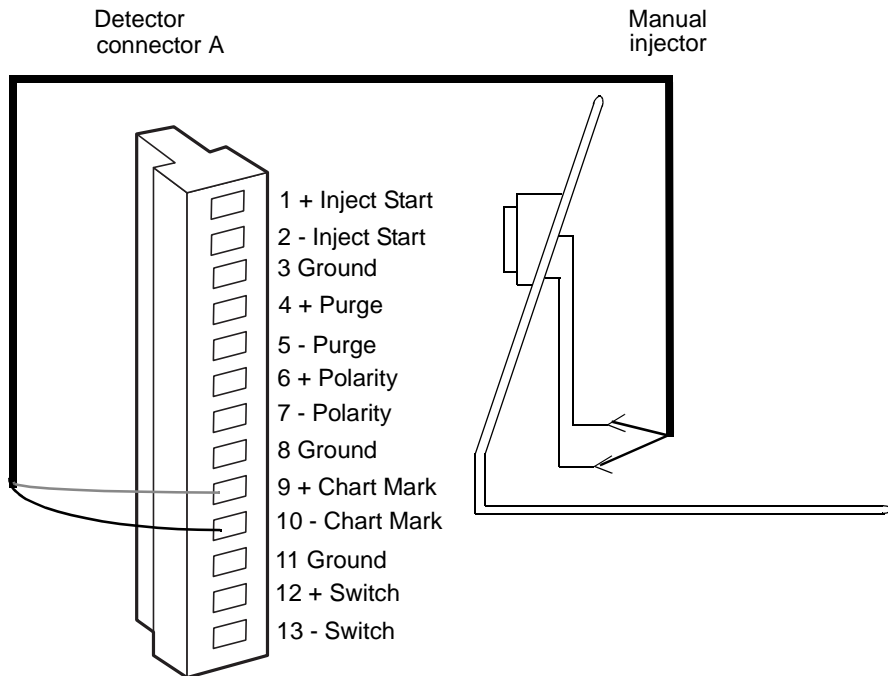

## Inject start connections to a manual injector

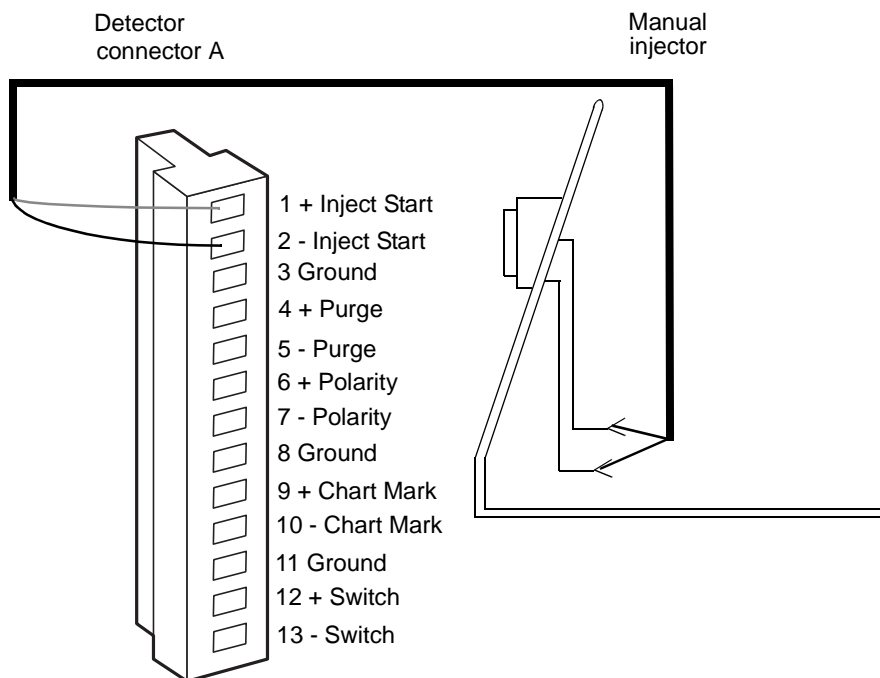

## Polarity connections

The Polarity and Polarity Enable contact closures on the rear panel of the 2414 detector determine the peak polarity of the output signal according to the following conditions (negative polarity results in negative, or inverted, peaks):

- Polarity serves as a positive/negative input.
- Polarity Enable serves as an external input (Polarity) enable.
- When Polarity Enable is open (not connected), the +/- key on the detector's front panel or an IEEE-488-connected data system (such as the Empower data system) determines the polarity.
- When Polarity Enable is closed (connected to an instrument), polarity determines peak polarity. Polarity open (disconnected) generates negative polarity. Polarity closed (connected) generates positive polarity.

The following table summarizes the polarity options.

### Polarity connection options

| Polarity enable | Polarity | Detector out polarity |
|-----------------|----------|-----------------------|
| Open            | Open     | No Effect             |
| Open            | Closed   | No Effect             |
| Closed          | Open     | Negative (Inverted)   |
| Closed          | Closed   | Unchanged             |

## Connecting to an external column heater

---

The 2414 detector can control one optional, external, column heater through the EXT 1 port (external column heater port) on its rear panel. The port is a standard 9-pin DIN connector.

### External column heater port

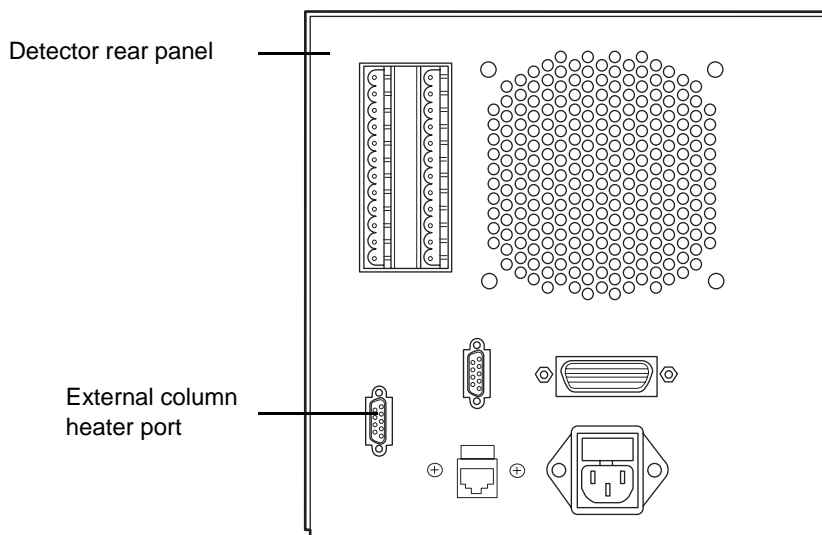





# 4 Preparing Solvents

Proper solvent selection and preparation are critical in differential refractometry to prevent baseline changes such as drift, noise, or an erratic baseline.



**Warning:** To avoid chemical hazards, always observe Good Laboratory Practices when handling solvents. Refer to the Material Safety Data Sheets shipped with solvents for handling information.

## Contents

| Topic                   | Page |
|-------------------------|------|
| Common solvent problems | 4-2  |
| Selecting a solvent     | 4-2  |
| Solvent degassing       | 4-5  |

## Common solvent problems

---

The 2414 detector measures changes in the refractive index (RI) of the solution flowing through the sample side of the flow cell. However, factors other than the presence of dissolved sample molecules can affect a solution's RI. Common problems include these conditions:

- Changes in temperature
- Changes in pressure
- Contaminants
- Separation of mixed solvents
- Outgassing of dissolved gases

## Selecting a solvent

---

An ideal solvent for your analysis has these characteristics:

- Good solubility characteristics for your application
- Significantly different RI than the sample components
- Satisfactory baseline noise performance
- Optimum optical sensitivity characteristics

## Solvent quality

Use spectral-grade or HPLC-grade solvents to better achieve these goals:

- Reproducible results
- Minimal instrument maintenance
- Minimal optical interference

A dirty or impure solvent can cause these problems:

- Baseline noise and drift
- Plugged columns
- Blockages in the fluid path

## Preparation checklist

The following solvent preparation guidelines help to ensure stable baselines and good resolution:

- Filter solvents with a 0.22- $\mu\text{m}$  filter.
- Degas the solvent.
- Stir the solvent.
- Protect solvents from drafts and shock.

## Water

Use water only from a high-quality water purification system. If the water system does not provide filtered water, filter it through a 0.22- $\mu\text{m}$  membrane filter before use.

## Buffers

When you use buffers, dissolve salts first, adjust the pH, and then filter to remove undissolved material.

## Tetrahydrofuran (THF)

When you use unstabilized THF, ensure that your solvent is fresh. Previously opened bottles of THF contain peroxide contaminants, which cause baseline drift.



**Warning:** THF contaminants (peroxides) can explode when desiccated or concentrated.

## Refractive indices of common solvents

The following table lists the refractive indices for some common chromatographic solvents. Consulting this table, verify that the solvent you

intend to use for your analysis has an RI significantly different from the sample components.

### Refractive indices of common solvents

| Solvent                      | RI     | Solvent                       | RI    |
|------------------------------|--------|-------------------------------|-------|
| Fluoroalkanes                | 1.25   | Tetrahydrofuran (THF)         | 1.408 |
| Hexafluoroisopropanol (HFIP) | 1.2752 | Amyl alcohol                  | 1.410 |
| Methanol                     | 1.329  | Diisobutylene                 | 1.411 |
| Water                        | 1.33   | <i>n</i> -Decane              | 1.412 |
| Acetonitrile                 | 1.344  | Amyl chloride                 | 1.413 |
| Ethyl ether                  | 1.353  | Dioxane                       | 1.422 |
| <i>n</i> -Pentane            | 1.358  | Ethyl bromide                 | 1.424 |
| Acetone                      | 1.359  | Methylene chloride            | 1.424 |
| Ethanol                      | 1.361  | Cyclohexane                   | 1.427 |
| Methyl acetate               | 1.362  | Ethylene glycol               | 1.427 |
| Isopropyl ether              | 1.368  | N,N-dimethyl formamide (DMF)  | 1.428 |
| Ethyl acetate                | 1.370  | N,N-dimethyl acetamide (DMAC) | 1.438 |
| 1-Pentene                    | 1.371  | Ethyl sulfide                 | 1.442 |
| Acetic acid                  | 1.372  | Chloroform                    | 1.443 |
| Isopropyl chloride           | 1.378  | Ethylene dichloride           | 1.445 |
| Isopropanol                  | 1.38   | Carbon tetrachloride          | 1.466 |
| <i>n</i> -Propanol           | 1.38   | Dimethyl sulfoxide (DMSO)     | 1.477 |
| Methylethylketone            | 1.381  | Toluene                       | 1.496 |
| Diethyl amine                | 1.387  | Xylene                        | ~1.50 |
| <i>n</i> -Propyl chloride    | 1.389  | Benzene                       | 1.501 |
| Methylisobutylketone         | 1.394  | Pyridine                      | 1.510 |
| Nitromethane                 | 1.394  | Chlorobenzene                 | 1.525 |
| 1-Nitropropane               | 1.400  | <i>o</i> -Chlorophenol        | 1.547 |

## Refractive indices of common solvents (Continued)

| Solvent      | RI    | Solvent          | RI    |
|--------------|-------|------------------|-------|
| Isooctane    | 1.404 | Aniline          | 1.586 |
| Cyclopentane | 1.406 | Carbon disulfide | 1.626 |

## Solvent degassing

---

Using degassed solvents is the most important step in solvent preparation. Degassing provides:

- Stable baselines and enhanced sensitivity
- Reproducible retention times
- Stable pump or solvent delivery system operation

This section presents information on the solubility of gases, solvent degassing methods, and solvent degassing considerations.

## Gas solubility

The amount of gas that can dissolve in a given volume of liquid depends on these factors:

- The chemical affinity of the gas for the liquid
- The temperature of the liquid
- The pressure applied to the liquid

Changes in the composition, temperature, or pressure of the mobile phase can lead to outgassing.

### Effects of intermolecular forces

Nonpolar gases ( $N_2$ ,  $O_2$ ,  $CO_2$ , He) are more soluble in nonpolar solvents than in polar solvents. Generally, a gas is most soluble in a solvent with intermolecular attractive forces similar to those in the gas ("like dissolves like").

### Effects of temperature

Temperature affects the solubility of gases. If the dissolution is exothermic, the solubility of the gas decreases when you heat the solvent. If the dissolution

is endothermic, the solubility increases when you heat the solvent. For example, the solubility of He in H<sub>2</sub>O decreases with an increase in temperature, but the solubility of He in benzene increases with an increase in temperature.

### Effects of partial pressure

The mass of gas dissolved in a given volume of solvent is proportional to the partial pressure of the gas in the vapor phase of the solvent. If you decrease the partial pressure of the gas, the amount of that gas in solution also decreases.

## Solvent degassing methods

Solvent degassing helps you attain a stable baseline and also improves reproducibility and pump performance.

There are two common methods used to degas solvents:

- Reducing pressure by vacuum
- Sonication

You can use these methods individually or in combination.

### Vacuum degassing

The in-line vacuum degasser operates on the principle of Henry's Law to remove dissolved gases from the solvent. Henry's Law states that the mole fraction of a gas dissolved in liquid is proportional to the partial pressure of that gas in the vapor phase above the liquid. If the partial pressure of a gas on the surface of the liquid is reduced, for example, by evacuation, then a proportional amount of that gas comes out of solution.

**Note:** Vacuum degassing can possibly change the composition of mixed solvents.

### Sonication

Sonication with high-energy sound waves drives energy into the solvent and causes the submicron-sized "bubbles" of gas to aggregate. As the gas bubbles aggregate, they become large enough to float out of the solvent and dissipate. Sonication alone degasses 4 liters of solvent in approximately 22 minutes.

## Solvent degassing considerations

Select the most efficient degassing operation for your application.

### Vacuum degassing

The longer a solvent is exposed to vacuum, the more dissolved gases are removed. Two factors affect the amount of time the solvent is exposed to the vacuum:

- Flow rate – At low flow rates, most of the dissolved gas is removed as the solvent passes through the vacuum chamber. At higher flow rates, lesser amounts of gas per unit volume of solvent are removed.
- Surface area of the degassing membrane – The length of the degassing membrane is fixed in each vacuum chamber. To increase the length of membrane, you can connect two or more vacuum chambers in series.

When you are using the Alliance separations module with the 2414 detector, set the in-line degasser to “on” degas mode.

### Sonication plus vacuum

Sonication combined with vacuum degasses solvent very quickly. This technique is less likely to change the composition of mixed solvents because the mixed solvents are held under vacuum for only a short time (less than a minute is usually sufficient).



**Warning:** To avoid injury from flying glass fragments, do not apply vacuum to the brown glass bottles in which solvent is shipped. There is a high risk of implosion under these conditions. Use a thick-walled container designed for vacuum applications.





# 5 Operating the Detector

## Contents

| Topic                              | Page |
|------------------------------------|------|
| Powering-on                        | 5-2  |
| Operating in RIU mode              | 5-10 |
| Operating in 410 (standalone) mode | 5-25 |
| Operating in 410 (remote) mode     | 5-30 |
| Configuring the detector           | 5-31 |
| Optimizing performance             | 5-35 |
| Powering-off                       | 5-39 |

# Powering-on

---

## Initializing

Before you power-on the 2414 detector, verify the connector from the detector's rear panel to the power source is properly installed.

To power-on the detector, press the on/off switch located on the lower-front right-hand corner of the unit.

At startup, the detector beeps three times and runs a series of startup diagnostic tests. If the detector passes all tests, the initial home (RIU or 410 mode) screen appears.

### Initial home screen (RIU mode)

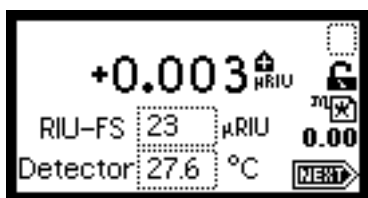

### Initial home screen (410 mode)

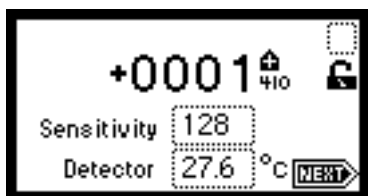

**Note:** The 2414 detector automatically switches to 410 mode, from RIU mode, when connected to a Waters data control system via the IEEE-488 or Ethernet connector.

When initialization is completed, you can change the default settings to suit your needs. You do this during initial startup and every time applications change. After initializing, the detector displays the first of four home screens. You can navigate to the various home screens using the Next key. For details, see [“Using the keypad” on page 5-3](#), and [“Navigating the user interface” on](#)

[page 5-9](#). In addition, there are two TEMP °C screens and three CONFIGURE screens, a METHODS menu, and a DIAGNOSTICS menu.

**Recommendation:** Review all of these screens when initially setting up the 2414 detector.

Note that it takes several hours for the optics bench to stabilize at a new temperature. Do not make a run until the temperature stabilizes. Changing temperature causes baseline drift and can necessitate LED reoptimization.

## Diagnostics failure at startup

If one or more of the internal startup diagnostics checks fails, the detector beeps and displays an error message.

## Using Help

The 2414 detector provides limited context-sensitive help. When you press “?” (Shift HOME) from a point in the program associated with an online Help screen, the Help screen appears.

### Example of Help screen

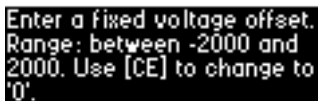

```
Enter a fixed voltage offset.  
Range: between -2000 and  
2000. Use [CE] to change to  
'0'.
```

Press Enter to dismiss the Help screen. If Help is not available for the function you are working on, pressing “?” gets no response.

## Using the keypad

The 2414 detector keypad consists of 24 keys providing these functions:

- Full numeric entry (10 digits plus a decimal point)
- Enter, Shift, CE (Clear Entry), Next, and online Help functions
- ▲ and ▼ (used for navigation only; pressing ▲ can also move the cursor to the left, ▼ to the right)

- Navigation to specific screens (HOME, TEMP °C, DIAGNOSTICS, TRACE, CONFIGURE, and METHOD)
- Primary function keys (Chart Mark, Auto Zero, Run/Stop, Reset Clock, Purge, Lock, Recycle, Polarity, System Information, Previous, Cancel, +/-, and Clear Field)
- Secondary function keys (Scale and Contrast)

## Detector keypad

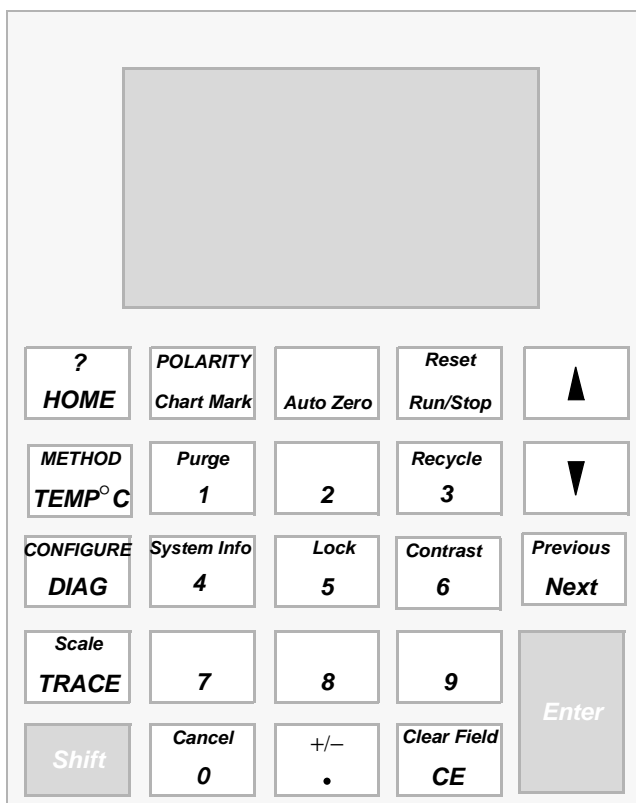



The effect of pressing a primary function key is immediate; no further entry is required. Secondary function keys require you to enter information into parameter fields and then press Enter for the functions to take effect.

Keys whose functions appear in uppercase letters (HOME, TEMP °C, DIAG, TRACE, METHOD, and CONFIGURE) effect the corresponding function from most screens.



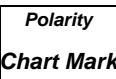

For numerical entries from 1 to 9 on choice lists or menus, enter the number corresponding to the desired item, and then press Enter. For the number 10, select 0, and then press Enter. To go to the end of a choice list, select “•”. For entries numbered 11 or 12, scroll to the desired item on the choice list, and then press Enter.

The following table explains the functions of the primary and secondary keys on the keypad.

### Keypad description

| Key   | Description   |   |
|---|---|---|
|   | Unshifted   | Shifted   |
|    | HOME – Displays the RIU screen containing the icons, and the RIU FS and Temp fields.  | ? – Displays context-sensitive Help when available.   |
|    | Chart Mark – Causes a momentary pulse to the analog output. This key has no effect if chart mark is disabled on Home screen 4.  | Polarity – Changes the algebraic sign of the output signal. Current polarity is indicated by icon.                        |
|   | Auto Zero – Sets the RIU offset so that the outputs, read 0 RIU. This key has no effect if Auto Zero is disabled. You can enable or disable the Auto Zero function key from the fourth Home screen (Figure ). | N/A   |
|  | Run/Stop – Starts or stops the current method. The elapsed time appears near the lower right side of the Home screen.   | Reset – Resets the detector run clock to zero minutes. Returns the detector to initial conditions for the current method. |

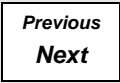
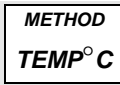
## Keypad description (Continued)

| Key  | Description   |   |
|--|---|---|
|  | Unshifted   | Shifted   |
| <br> | <p>▲, ▼ – On screens with entry fields (edit, check box, or choice list), the active field has a thickened border. Use the arrow keys to make a different field active. (▲ moves up or left; ▼ moves down or right.) On screens with a scrollable list, these keys move the highlight up (toward the beginning of the list) or down (toward the end). Other screens can have special instructions for the use of the ▲ and ▼ keys (for example, the Display Contrast screen).</p> |   |
|   | <p>Next – Displays a screen with additional options related to the current screen. Repeated pressing of this key always brings back the original screen. On most screens where this key is active, the NEXT arrow appears in the lower-right corner of the display.</p>   | <p>Previous – When the Next key is available, the “previous” function lets you navigate through the screens in the reverse order.</p>               |
|    | <p>TEMP °C – The page where you set detector oven and column heater module (CHM) temperatures. The allowable values (set points) for the detector oven is 30 to 55 °C. For the column heater module, it is 30 to 150 °C.</p> <p>The minimum stable set point is typically 5 °C above the ambient temperature</p>  | <p>METHOD – Displays the list of options for creating, storing, retrieving, and resetting methods, which contain timed and/or threshold events.</p> |
|   | <p>DIAG – Displays the choice list of diagnostic routines.</p>  | <p>CONFIGURE – Displays the first Configuration screen.</p>   |

## Keypad description (Continued)

| Key  | Description   |   |
|--|---|---|
|  | Unshifted   | Shifted   |
| <div style="border: 1px solid black; padding: 2px; text-align: center;"> <i>Scale</i><br/> <b>TRACE</b> </div>   | TRACE – Displays the RIU monitor trace.   | Scale – When the RIU trace screen is visible, this function permits modification of the display range in the X (time) and Y (RIU) dimensions. |
| <div style="border: 1px solid black; padding: 2px; text-align: center;"> <b>Shift</b> </div>                     | Shift – Enables the shifted functions (identified by the text at the top of most keys). The shifted state is temporary, and is reset after the next keystroke.                                      |   |
| <div style="border: 1px solid black; padding: 2px; text-align: center;"> <b>0-9</b> </div>                       | 0-9 – Enters the corresponding number into the current field. Also positions the cursor at the corresponding entry in a list (0 = tenth item). Selects the corresponding number from a choice list. | 0-9 – See descriptions for specific shifted numeric keys.   |
| <div style="border: 1px solid black; padding: 2px; text-align: center;"> <i>Purge</i><br/> <b>1</b> </div>       | 1 – See 0-9 above.  | Purge – Toggles the unit in and out of the Purge mode. The current purge state is indicated by icon.  |
| <div style="border: 1px solid black; padding: 2px; text-align: center;"> <i>Recycle</i><br/> <b>3</b> </div>     | 3 – See 0-9 above.  | Recycle – Activate the recycle or diverter valve. Recycle is a toggle function. The current recycle state is indicated by icon.               |
| <div style="border: 1px solid black; padding: 2px; text-align: center;"> <i>System Info</i><br/> <b>4</b> </div> | 4 – See 0-9 above.  | System Info – Displays system information including software version, IEEE address, and instrument serial number.                             |

## Keypad description (Continued)

| Key   | Description  |  |
|---|--|--|
|   | Unshifted  | Shifted  |
| <div style="border: 1px solid black; padding: 5px; width: fit-content; margin: auto;"> <i>Lock</i><br/>5         </div>     | 5 – See 0–9 above.   | Lock – When you are on the home screen, enables or disables the keypad lock feature. Use the lock function to prevent inadvertent changes to detector settings. The current lock state is indicated by an icon on the home screen. |
| <div style="border: 1px solid black; padding: 5px; width: fit-content; margin: auto;"> <i>Contrast</i><br/>6         </div> | 6 – See 0–9 above.   | Contrast – Permits adjustment of contrast of the liquid crystal display.   |
| <div style="border: 1px solid black; padding: 5px; width: fit-content; margin: auto;"> <i>Cancel</i><br/>0         </div>   | 0 – See 0–9 above.   | Cancel – In some fields, the Cancel function backs out of a prompt without completing the task. The word “Cancel” appears as a cue in the lower-right border of the message text.  |
| <div style="border: 1px solid black; padding: 5px; width: fit-content; margin: auto;">           +/-<br/>•         </div>   | • – Enters a decimal point. Also positions the cursor at the last entry in a list. | +/- – Some edit fields accept negative number entries. Use this function to invert the sign of the number in the active field.   |

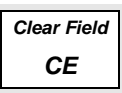
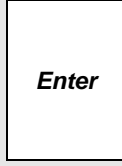

## Keypad description (Continued)

| Key   | Description   |  |
|---|---|--|
|   | Unshifted   | Shifted  |
|  | CE – Clears an editing change, and returns the contents of a field to its previous value. Sets the value to a unique word for some fields. For example, in the voltage offset diagnostic, you can enter either a numeric offset value or press CE to change it to OFF.            | Clear Field – Blanks the current entry field before entering the desired values. |
|  | Enter – Completes the entry in an edit field. Also advances the active field as if the Down arrow had been pressed. Press Enter to acknowledge error messages and other prompts. In these cases, the word “Enter” appears as a cue in the lower-right border of the message text. |  |

## Navigating the user interface

When operating the 2414 detector use these steps to navigate through its screens and menus:

1. Press the Enter key (or the ▲ and ▼ keys) to navigate among editable fields on a display.

**Result:** A thickened border appears around the active field.

2. Press Enter to advance the active field once you complete an entry.

**Notes:**

- If you make an error, press CE (clear entry) to undo any changes and return to the active entry field.
  - An active field containing a choice list is indicated by a number to the right of the field, within the thickened border.
3. To display a choice list, press Enter, and then do one of the following steps:

- Press the corresponding number key to select an item immediately.
- Use the ▲ and ▼ keys to scroll through the list, and then press Enter.

**Note:** The ▲ and ▼ keys do not increment or decrement numerical field entries. Instead, use the numerical keypad.

## Operating in RIU mode

RIU mode is the detector's default standalone mode that provides front-panel method programmability. RIU mode sets  $\mu$ RIU as the parameter displayed on the front panel and generated at the detector output, using the RIU-FS parameter to convert RIU to a voltage.

### Using the display in RIU mode

The detector provides a  $128 \times 64$  bitmap graphic display and a 24-key membrane keypad as the operator interface. After the startup diagnostics run successfully, the detector displays the home screen.

#### Home screen RIU mode

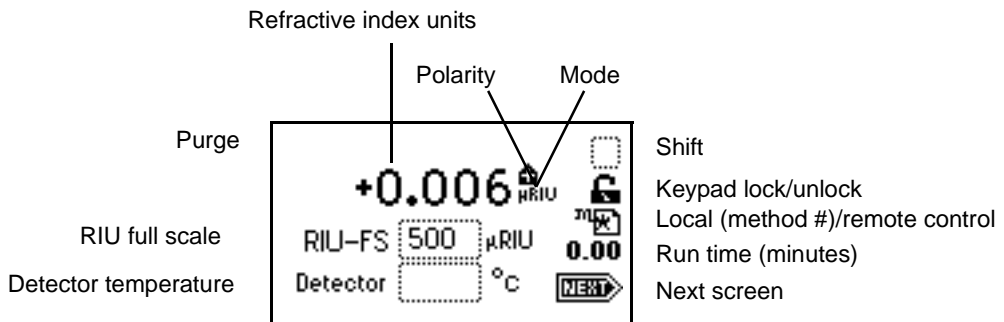



You can recall the home screen from any page by pressing the HOME key. At the first use of the detector, the home screen shows the factory-set defaults. After the first use, the home screen shows the settings displayed before the detector was last powered-off.







## Refractive index, function, and message icons

The HOME, TEMP °C, and CONFIGURE screens in the detector program display the icons or fields shown in the figure above.

### Mode, function, and message screen icons

| Icon or field   | Icon/field name         | Function   |
|---|-------------------------|--|
| Home1(status),<br>Home2(entry)  | RIU-FS                  | Shows the current RIU-FS setting.  |
| Home1(status),<br>Temp °C (entry)   | Detector<br>Temperature | Shows the current temperature of detector oven.  |
| Numerical field   | RIU                     | Displays current refractive index in $\mu$ RIU ( $1 \times 10^{-6}$ refractive index units). |
|    | Shift Off/ On           | Blank = Shift off<br>▲ = Shift on  |
|   | Keypad Unlock /<br>Lock | Open lock = Unrestricted keypad entry<br>Closed lock = Parameter changes not allowed         |
|  | Sticky Diagnostics      | When the home screen displays the wrench icon, a sticky diagnostic is active.                |

## Mode, function, and message screen icons (Continued)

| Icon or field   | Icon/field name                   | Function  |
|---|-----------------------------------|---|
|    | Local (Method #) / Remote Control | <p>Local/Method number – If the detector is not controlled by a data system or other control device over the IEEE-488 bus, it displays a cursive “m” and the current method number or an asterisk that indicates current conditions are not stored as a method.</p> <p>Remote/IEEE address – If the detector is controlled by a data system or other control device over the IEEE-488 bus, it displays a remote control icon containing the IEEE address.</p> |
| Numerical field   | Run Time (Minutes)                | Displays the time elapsed since you pressed the Run key, or since an inject start signal was received.  |
|  | Next                              | Indicates that pressing Next brings you to additional screens.  |
|  | Polarity                          | Display icon indicates current polarity of RIU output.  |
|  | Purge                             | Purge is active   |
|  | Recycle                           | Recycle or Divert Valve is active.  |
|  |                                   | Message screen icons (from left): Error, Question, Information, and Warning.  |

## Navigating to and from the home screen in RIU mode

Pressing HOME brings you to the home screen, from most screens. From the home screen, you can access several secondary functions. To move to the secondary function screens of the home screen, press Next. These are the secondary functions in RIU mode:

- RIU-FS
- Filter type
- Time constant
- Voltage offset
- $\mu$ RIU offset
- Enable/disable keypad entries

The parameters you enter into the secondary function fields become part of the current method conditions and are stored when you store the method.

## Secondary functions of the RIU mode home screen

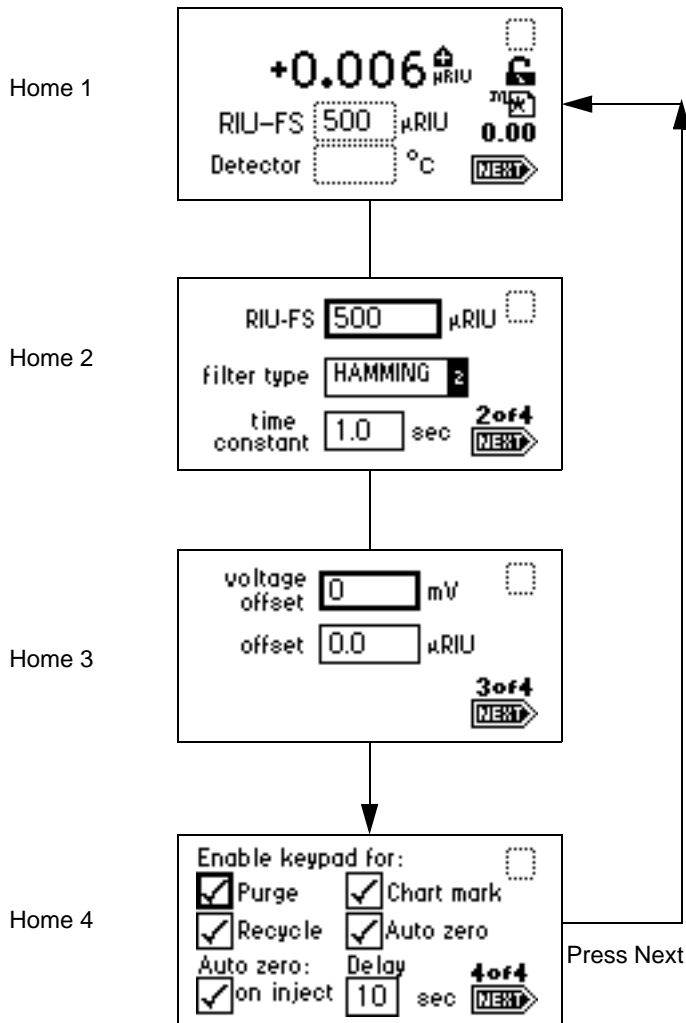

From the home screen, you can access the following functions, either from the home screen or by pressing the Next key:

- RIU-FS (refractive index units full scale) – The refractive index output signal is defined by the following relationship:  

$$\text{RIU OUT} = \Delta n * (2 \text{ Volts} / \text{RIU FS})$$

The RIU-FS range is 500 to 1  $\mu$ RIU (default is 500).



**Warning:** Changing the Refractive Index Units Full Scale (RIU-FS) setting affects the 2-V Detector output.

The RIU Full Scale setting is a parameter used to generate an analog output voltage (detector output) with the appropriate scaling factor. The value, expressed in  $\mu$ RIU, corresponds to the RI value where the analog outputs will saturate at their full scale values. A RIU-FS setting of 500  $\mu$ RIU means that a  $\pm 500$   $\mu$ RIU signal will generate a  $\pm 2$  V output signal. RIU-FS does not affect the value displayed on the front panel.

#### 410 mode and RIU mode conversion factors and equivalencies

| Sensitivity | Factor nRIU/mV | Equivalent $\mu$ RIU-FS |
|-------------|----------------|-------------------------|
| 1           | 5000.000       | 10000                   |
| 2           | 2500.000       | 5000                    |
| 4           | 1250.000       | 2500                    |
| 8           | 625.000        | 1250                    |
| 16          | 312.500        | 625                     |
| 32          | 156.250        | 313                     |
| 64          | 78.125         | 156                     |
| 128         | 39.063         | 78                      |
| 256         | 19.531         | 39                      |
| 512         | 9.766          | 20                      |
| 1024        | 4.883          | 10                      |

- Filter type – Selected via the front panel, timed event, or remote interface of either Hamming or RC filter type. The filter type defaults to Hamming in RIU mode and RC in 410 mode.
- Time constant – Set via the front panel, timed event, or remote interface. Adjusts the noise filter (time constant) to achieve the optimum signal-to-noise ratio without changing the sensitivity setting. The settable range of the Hamming filter is 0.1 to 5.0 seconds in 0.1-second increments (default is 1.0 second). For the RC filter, the range is 0.1 to 10.0 seconds in 0.1-second increments.

- Voltage offset – Adjusts the charted analog output signal. Entered in mV, voltage offset adjusts the 2-V signal by the entered value (0- to 2000-mV range). This is useful for making minor adjustments, and for nulling any offset between the 2414 refractive index detector and a connected external data system.  
  - $\mu$ RIU offset – Provides an offset for adjusting the detector output. The default is 0.0  $\mu$ RIU and the range is  $\pm 500.0$   $\mu$ RIU.
- Enable keypad auto zero – Selected by default, this parameter results in an auto zero each time an auto zero is requested via the front panel. You can disable this parameter by pressing any numerical key to deselect this box.
- Enable keypad chart mark – Selected by default, this parameter results in an chart mark each time an chart mark is requested via the front panel. You can disable this parameter by pressing any numerical key to deselect this box.
- Enable keypad purge – Selected by default, this parameter results in a purge each time one is requested via the front panel. You can disable this parameter by pressing any numerical key to clear this box.
- Enable keypad recycle – Selected by default, this parameter results in a recycle each time one is requested via the front panel. You can disable this parameter by pressing any numerical key to clear this box.
- Auto zero on inject – Selected by default, this parameter results in an auto zero each time an inject start signal is received by the detector via contact closure, IEEE-488, or the front panel. You can disable this parameter by pressing any numerical key to deselect this box.
- Auto zero delay – Invoked only on autozeros requested from an event input or remote interface, not from the front panel. The delay range is 0 to 30 seconds (default is 10 seconds), and the front panel counts down the delay in seconds.
- Enable keypad chart mark – Selected by default, this parameter results in a chart mark each time one is requested via contact closure or through the front panel. You can disable this parameter by pressing any numerical key to clear this box.

## Setting up a run in RIU mode

Once you press HOME to return to the home screen and select a Detector Output mode (“[Configuring the detector](#)” on page 5-31), you are ready to set



the detector up for a run. In addition to Detector Output mode, you must program the following parameters before beginning a run:

- Attenuation (RIU-FS)
- Filter type
- Time constant
- Detector oven temperature
- Column heater module temperature (if available or present)

Depending on other functions you can choose to perform during a run, there are several other parameters you must program. The table on [page 5-11](#) contains the function descriptions, fields, screen number, type of function, display units, allowable ranges, and the default settings for the home screen and the secondary function screens.

## Programming timed events, threshold events, and methods

**Note:** Programmed methods are available in RIU mode only.

The detector allows you to store and retrieve up to 10 methods. The detector references stored methods by 1 to 10. An asterisk in the method number icon indicates the current conditions are not stored. If you are operating using a stored method, then the method number is displayed on the RIU mode initial home screen.

If you edit a parameter such as RIU-FS or temperature, you are editing the current conditions (Method \*), which you can store as a method. You can store the method in one of the 10 available method storage slots, or you can replace it with one of the previously stored methods. When you retrieve a previously stored method, you replace the existing method conditions with those of the stored method. The method number displayed on the home screen is that of the retrieved method until you make a change. Any parameter change (for example, RIU-FS or temperature) alters the current conditions so that the original recalled method is no longer in effect, causing the method number to change to an asterisk.

If the detector is powered-off for any reason and restarted, the operating parameters at the time of system shutdown are restored.

On startup, you always see an asterisk inside the method icon on the RIU mode Home screen.

**Note:** When the detector is operating under 410 mode, the method icon is not present or if under control by a system controller of a data system, the remote icon is displayed.

The detector method includes all parameters that are necessary to reproduce a chromatographic separation.

### Timed events

You can program up to 16 timed events to the nearest 0.01 minute. As you enter timed events, each new event is appended to the end of the timed event list. If you enter a time that is not in sequence with the events entered previously, the timed event list is sorted automatically when you press Next. The 2414 detector allows programming of the timed events shown in the following table.

#### Timed event parameter

| Number | Event         | Units          | Range   | Default  |
|--------|---------------|----------------|---|----------|
| 1      | AutoZero      | Does not apply | Does not apply  | Disabled |
| 2      | Polarity      | Does not apply | 1. -<br>2. +  | +        |
| 3      | RIU-FS        | μRIU           | 1 to 500  | Disabled |
| 4      | Chart mark    | Does not apply | Does not apply  | Disabled |
| 5      | Start Purge   | Does not apply | Does not apply  | Disabled |
| 6      | End Purge     | Does not apply | Does not apply  | Disabled |
| 7      | Switch        | μRIU           | 1. On<br>2. Off<br>3. Pulse<br>4. Rectangular Wave<br>5. Toggle | Disabled |
| 8      | Threshold     | μRIU           | 0.001 to 500.000  | Disabled |
| 9      | Start Recycle | Does not apply | Does not apply  | Disabled |
| 10     | End Recycle   | Does not apply | Does not apply  | Disabled |

## To program a new timed event

1. On the keypad, press the METHOD (Shift TEMP °C) key.

### Method choice list screen



2. From the Method choice list, press 1, Timed events.

**Result:** An active field for entering the time of the event is displayed.

3. Enter the time for the event. When you begin entering the time, additional fields appear.

### Timed events screen

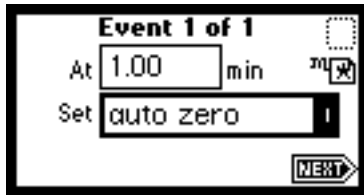

4. Press Enter to enter the time.
5. To advance to the Set field (Events choice list), press the ▼ key.
6. Press Enter again to display the choice list, or, if you know the event number, press the number for the event you are programming.
7. Enter the appropriate selection in the To field, if the To field is displayed.
8. Press Next to advance to a new timed event.
9. To delete a timed event, press CE when the time field is active to change it to OFF.

10. Press HOME to return to the RIU mode home screen, and then press Run/Stop to start the current method or METHOD to return to the method choice list to store the method.

11. Press Reset to reset the run clock to 0.

If the 2414 detector is configured with the Waters 717plus Autosampler or another external device, the inject start programmed from that device starts the method.

**Note:** If you are working in real time, under current conditions (method \*), at a power failure or shutdown you lose all timed or threshold events that were not previously stored as a method. See the discussion “Storing a Method” later in this section.

### Threshold events

Using threshold events you can control the switch contact closure output to trigger, for example, a fraction collector. You can program the switch to change its status on the detector whenever the detector output goes above a specified threshold RIU value. This threshold detection ability is available in addition to actuating the switch by time, as described in the section above. Below the specified threshold, the switch is set as shown in the following table.

**Note:** Threshold events can only be programmed for positive values of  $\mu$ RIU.

### Threshold event “To” parameters

| Number | Switch                          | Below threshold switch state |
|--------|---------------------------------|------------------------------|
| 1      | On                              | Off                          |
| 2      | Off                             | On                           |
| 3      | Pulse                           | Off                          |
| 4      | Rect Wave<br>(Rectangular Wave) | Off                          |
| 5      | Toggle                          | Toggle                       |

To define the pulse period of the frequency of a wave, see [“Accessing the Configuration screens” on page 5-31](#).

## To program a threshold event

1. On the keypad, press the METHOD (Shift Temp×C) key.
2. From the Method choice list, press 2, Threshold events.

**Result:** An active field (Above) (mRIU) for entering the threshold appears. When you enter the number in the (Above) field to specify the threshold value required in mRIU, an additional field is displayed (Switch).

### Threshold events screen



**Tip:** The “threshold” selection in the table on [page 5-18](#) allows you to modify this initial Threshold value as a timed event.

3. Press Enter to advance to the next (Switch) field, or press the ▲ or ▼ key to move among the five fields on the threshold events screen.
4. When the Switch field is active, press Enter to display the threshold events choice list or press the number corresponding to the event you are programming.

**Note:** To disable the Threshold event, press CE and Enter in the Above field (μRIU).

## Storing a method

A method consists of all programmable parameters on the RIU Mode home and associated screens, as well as timed and threshold events. You can store the current method by selecting a location from 1 to 10.

### To store a method

1. Press METHOD (Shift Temp ×C) to return to the Method choice list.

2. From the Method choice list, press 4, Store method \*. A method number field appears.



**Caution:** There is no warning message if the method number you select is already being used by a previously stored method. When you enter a number and press Enter, the current method conditions are stored, overwriting any previous method stored in the same slot.

### Method choice list



3. Enter a number from 1 to 10 and press Enter.

**Result:** A brief message (“Storing \* as method *n*”) appears. When the display returns to the Method choice list, the method is stored.

### Retrieving a method

#### To retrieve a previously stored method

1. Return to the Method choice list by pressing METHOD (Shift Temp ×C).
2. Press 3, Retrieve a method.

**Result:** The last method number stored or retrieved is displayed in the method number box.

3. Enter the number of the method you want to retrieve and press Enter.

**Result:** A brief message (“Retrieving method *n*”) appears.

When the display returns to the Method choice list, the method number you specified appears within the method number icon.

## Viewing events within a method

### To view timed and threshold events that make up a stored method

1. Retrieve the method (as described above).
2. With the number of the method appearing in the method number box, press 1 to view the Timed events or 2 to view Threshold events within the displayed method.

**Note:** If you make a change to a timed or threshold event within a method, the asterisk is displayed (Method \*) indicating that the method (\*) is no longer the same as the stored method you retrieved in step 1. You can then store the method containing the altered event(s) in the same storage slot.

## Resetting a method

Resetting a stored method is a two-step process. First, you reset the current conditions to the defaults; then you save the defaults in one of the storage locations.

### To clear one or more methods

**Note:** Before you clear the method, to prevent loss of the current conditions, store them in one of the available storage slots. After you cleared the storage slots, you can restore the previous conditions.

1. Return to the Method choice list by pressing METHOD (Shift Temp °C).
2. Press 5, Reset method \*.

**Result:** You are prompted to verify if it is OK to set current conditions to factory defaults.

### Reset method message

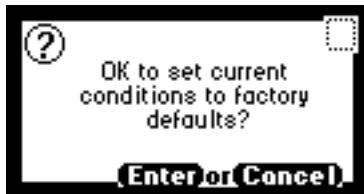

- If you press Enter, the following conditions occur:
    - All timed events are deleted.
    - All threshold events are disabled.
    - All other operating parameters of the method (RIU-FS, Filter, Time Constant, etc.) are set to defaults.
  - If you press Cancel (Shift 0), the display returns to the Method choice list.
3. Press 4, Store method, and enter a storage location number.
  4. To clear other stored methods, press Cancel (Shift 0), the display returns to the Method choice list.

**Note:** When you return to the RIU mode home screen by pressing HOME, the method number icon displays an asterisk.

## Clearing events

You can clear only timed or threshold events without resetting any other operating parameters.

### To clear all active timed or threshold events

1. Return to the Method choice list by pressing METHOD (Shift Temp×C).
2. Press 6, Clear events.

**Result:** You are prompted to verify if it is OK to clear all active events.

### Clear events message





- If you press Enter:
  - All timed and threshold events in the method are cleared.
  - All other operating parameters of the method (RIU-FS, Filter, and so on) are unaffected.
- If you press Cancel (Shift 0), the display returns to the Method choice list.

**Note:** When you return to the RIU mode home screen by pressing HOME, the method number icon displays an asterisk.

## Operating in 410 (standalone) mode

---

Unlike RIU mode, you cannot program or use methods stored in the 2414 detector in 410 mode. The 410 (standalone) mode emulates the Waters 410/2410 by displaying the % Full Scale value used by the Waters 410 and 2410 Detectors and driving the Detector Out signal on the 2414 detector output.

To switch the detector from RIU mode to 410 mode, press the CONFIGURE key (see “[Setting detector mode](#)” on page 5-32).

**Note:** If you are using the detector under remote control by a Waters data control system, such as Empower, it automatically switches to 410 mode (see “[Operating in 410 \(remote\) mode](#)” on page 5-30).

## Using the display in 410 mode

The detector provides a 128 × 64 bitmap graphic display and a 24-key membrane keypad as the operator interface. After the startup diagnostics run successfully, the detector displays the 410 mode home screen.

## Home screen 410 mode

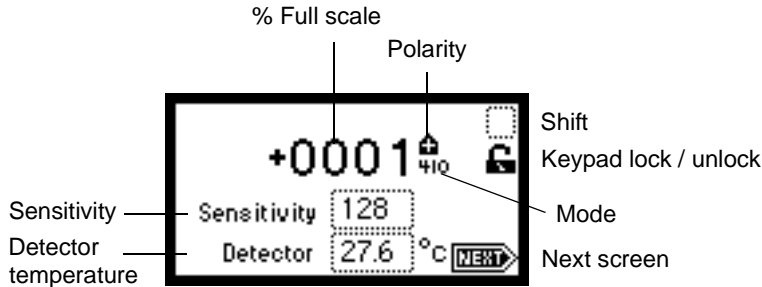

You can recall the home screen from any page by pressing the HOME key. At the first use of the detector, the home screen shows the factory-set defaults. After the first use, the home screen shows the settings displayed before the detector was last powered-off.













## Refractive index, function, and message icons in 410 mode

The HOME, TEMP °C, and CONFIGURE screens in the detector program display the icons or fields described in the table below. For a list of ranges and defaults for the function icons and fields in 410 mode, see the table on [page 5-18](#).

### Mode, function, and message screen icons

| Icon or field   | Icon/field name      | Function  |
|---|----------------------|---|
| Home1 (status),<br>Home2 (entry)  | Sensitivity          | Shows the current sensitivity setting.                      |
| Home1 (status),<br>Temp °C (entry)  | Detector Temperature | Shows the current temperature of detector oven.             |
| Numerical field   | % Full Scale         | Displays RIU value as % full range for a given sensitivity. |
|  | Shift Off/ On        | Blank = Shift off<br>▲ = Shift on                           |

## Mode, function, and message screen icons (Continued)

| Icon or field  | Icon/field name      | Function   |
|--|----------------------|--|
| <br>   | Keypad Unlock / Lock | Open lock = Unrestricted keypad entry<br>Closed lock = Parameter changes not allowed |
|   | Sticky Diagnostics   | When the Home screen displays the wrench icon, a sticky diagnostic is active.        |
|   | Next                 | Indicates that pressing Next brings you to additional screens.                       |
| <br>   | Polarity             | Display icon indicates current polarity of RIU output.                               |
|   | Purge                | Purge is active  |
|   | Recycle              | Recycle or Divert Valve is on.   |
| <br><br><br> |                      | Message screen icons (from left): Error, Question, Information, and Warning.         |

## Navigating to and from the home screen in 410 mode

Pressing HOME brings you to the home screen, from most screens. From the home screen, you can access several secondary functions. To move to the secondary function screens of the home screen, press Next. These are the secondary functions in 410 mode:

- Sensitivity
- Filter type
- Time constant

- Voltage offset
- Enable/disable keypad entries

### Secondary functions of the 410 mode home screen

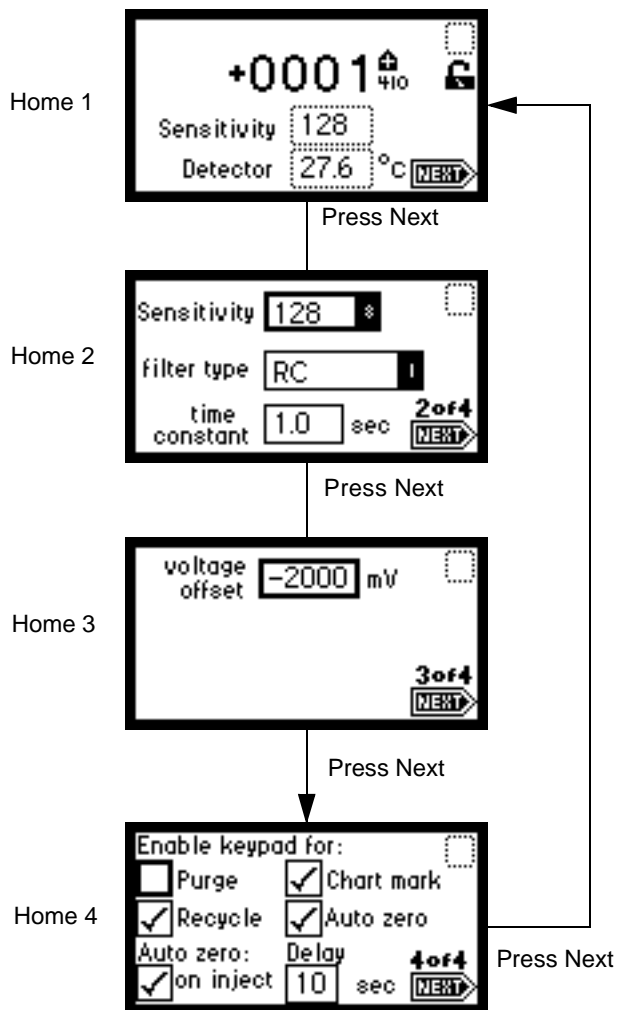

From the home screen, you can access the following functions, either from the home screen or by pressing the Next key:

- **Sensitivity**– The Waters 410-compatible Integrator Output signal is defined by the following relationship:

$$\text{Detector Out} = [\Delta n / (5 \times 10^{-3} \text{ RIU} / \text{Volt})] \times \text{SENS}$$

Sensitivity settings are 1, 2, 4, 8, 16, 32, 64, 128, 256, 512, and 1024 (default is 4).

Sensitivity is a parameter used to generate the Waters 410-compatible Integrator Output signal. The user interface provides a means for setting Sensitivity as well as displaying it.

When you select this output type, the front panel display's % Full Scale as the measured parameter.

#### 410 mode and RIU mode conversion factors and equivalencies

| Sensitivity | Factor nRIU/mV | Equivalent $\mu$ RIU-FS |
|-------------|----------------|-------------------------|
| 1           | 5000.000       | 10000                   |
| 2           | 2500.000       | 5000                    |
| 4           | 1250.000       | 2500                    |
| 8           | 625.000        | 1250                    |
| 16          | 312.500        | 625                     |
| 32          | 156.250        | 313                     |
| 64          | 78.125         | 156                     |
| 128         | 39.063         | 78                      |
| 256         | 19.531         | 39                      |
| 512         | 9.766          | 20                      |
| 1024        | 4.883          | 10                      |

- **Filter type** – Selected via front panel, timed event, and remote interface of either Hamming or RC filter type.

If the Detector mode is set to 410 mode, the Filter type is set to RC.

- **Time constant** – Set via front panel, timed event, and remote interface. For the RC filter, the settable range is 0.1 to 10.0 seconds, in 0.1-second increments.

- Voltage offset – This parameter, expressed in mV, is used to shift the chromatogram charted from the analog output in a positive or negative direction. This is used to null any offsets between the detector and a connected chart recorder or data system. The offset is added after any polarity has been applied to the output (default is 0 mV).

Voltage offset range is 0 to 2000 mV.

- Auto zero on inject – The Auto Zero On Inject Enable will enable an autozero to be invoked when an inject start input event is received. This parameter will be set either from the front panel or remote interface.
- Auto zero delay – This delay will only be invoked on autozeros requested from an event input or remote interface, not from the front panel. The range is 0 to 30 seconds (default is 10 seconds).

## Setting up a run in 410 mode

Once you press HOME to return to the home screen and select a Detector Output mode (see [“Configuring the detector” on page 5-31](#)), you are ready to set the detector up for a run. In addition to Detector Output mode, you must program the following parameters before beginning a run:

- Sensitivity
- Time constant
- Detector oven temperature
- Column heater module temperature (if available or present)

Depending on other functions you can choose to perform during a run, there are several other parameters you need to program. The table on [page 5-26](#) contains the function descriptions, fields, screen number, type of function, display units, allowable ranges, and the default settings for the Home screen and the secondary function screens.

## Operating in 410 (remote) mode

---

The 2414 detector operates in 410 (remote) mode when it is under active control by a Waters data control system or system controller, such is the case when it is connected to any of these systems:

- A data control system running Empower 2 Chromatography Software connected to the detector via the Ethernet connector

- A data control system running Empower or Millennium<sup>32</sup> Chromatography Software connected to the detector via the IEEE-488 bus (see “[Connecting to a Waters data control system via the IEEE-488 bus interface](#)” on page 3-5)
- An Alliance separations module or 600E Multisolvent Delivery System (see “[Connecting to a Waters PowerLine system controller via the IEEE-488 bus interface](#)” on page 3-7)
- A standalone Alliance Separations Module (see “[Connecting to a standalone Alliance Separations Module](#)” on page 3-12)
- a 746 Data Module (see “[Connecting to the Waters 746 Data Module](#)” on page 3-16)

With a data control system, you use the data control software to create instrument methods and method sets to control the 2414 detector and other HPLC system components. See the data control software documentation for more information on configuring the 2414 detector and operating in 410 (remote) mode.

**Note:** For details on the supported 2414 detector’s software and firmware requirements, see the Waters 2414 Refractive Index Detector release notes.

## Configuring the detector

### Accessing the Configuration screens

To access the Configuration screens, press the CONFIGURE key (Shift DIAG). The first of three Configuration screens appears.

### Configuration screens

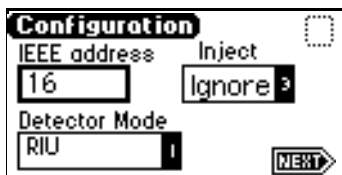

Configuration screen 1

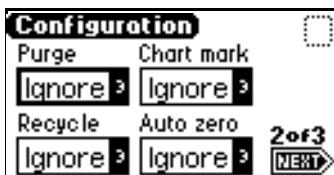

Configuration screen 2

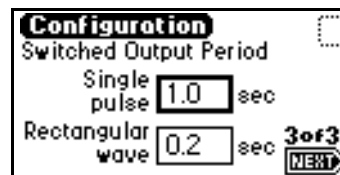

Configuration screen 3

## Setting the IEEE address

IEEE address – Enter the detector’s IEEE-488 bus address, from 2 through 29. If you press the CE key, the detector is removed from IEEE control. The default IEEE address is 14.

## Setting detector mode

**Note:** When connected to the data control software, the detector defaults to 410 mode.

Use the Detector mode to set the detector in RIU mode or 410 mode.

## Configuring event inputs (contact closures)

**Note:** On startup, the detector switches are set to “ignore”.

Use these fields on the first and second Configuration screens:

- Inject – Specify the Inject input to signal the start of a run.
  - High – Start run when contact closure changes from off (open) to on (closed).
  - Low – Start run when contact closure changes from on (closed) to off (open).
  - Ignore – Do not respond to Inject start input. This is the default setting.

Use the Enter key and the numeric keypad or the ▲ and ▼ keys to select the appropriate entry. This event resets the run-time clock and applies the initial method conditions immediately.

- Chart mark – Specify the Chart mark input to create a chart mark on the Detector Out signal. You determine the response of the channel using the enable chart mark function explained in the table on [page 5-18](#) and shown in the figure on [page 5-14](#).
  - High – Create chart mark(s) when contact closure changes from off (open) to on (closed).
  - Low – Create chart mark(s) when contact closure changes from on (closed) to off (open).
  - Ignore – Do not respond to Chart mark input. This is the default setting.



Use the Enter key and the numeric keypad or the ▲ and ▼ keys to select the appropriate entry.

- Auto zero – Configure the Auto Zero input to auto zero the refractive index output. You determine the response of the channel using the Enable Auto Zero function explained in the table on [page 5-18](#) and shown in the figure on [page 5-14](#).
  - High – Auto zero the channel when contact closure changes from off (open) to on (closed).
  - Low – Auto zero the channel when contact closure changes from on (closed) to off (open).
  - Ignore – Do not respond to Auto Zero input. This is the default setting.
- Purge – Configure the Purge input to place the unit into Purge mode.
  - High – If the contact closure is open, the unit is put into Purge mode. If the contact closure is closed, the unit is taken out of Purge mode.
  - Low – If the contact closure is closed, the unit is put into Purge mode. If the contact closure is open, the unit is taken out of Purge mode.
  - Ignore – Do not respond to Purge input. This is the default setting.
- Recycle – Configure the recycle input to turn on diverter valve.
  - High – If the contact closure is open, the unit is put into Recycle mode. If the contact closure is closed, the unit is taken out of Recycle mode.
  - Low – If the contact closure is closed, the unit is put into Recycle mode. If the contact closure is open, the unit is taken out of Recycle mode.
  - Ignore – Do not respond to Recycle input. This is the default setting.

### Setting pulse periods

Use the third Configuration screen to set pulse or signal width or to activate a pulse or rectangular wave on SW1.

- Single pulse (in seconds) – If the switch is programmed to generate a pulse as a timed or threshold event, then the period of the signal (single pulse width) is as specified in this field (range is 0.1 to 60 seconds).

- Rectangular wave (in seconds) – If the switch is programmed to initiate a rectangular wave as a timed or threshold event, then the period of the signal (the width of one pulse period in a rectangular wave or pulse train) is as specified in this field (range is 0.2 to 60 seconds).

The following figure shows the difference between a single pulse and a rectangular wave.

### Setting the pulse period or signal width using the switch

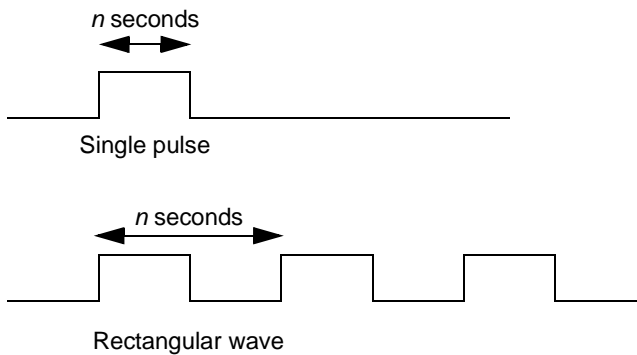

### Setting display contrast

Use the Contrast function to adjust the contrast of the detector display screen. When you press the Contrast key (Shift 6), the Display Contrast screen appears.

#### Display contrast screen

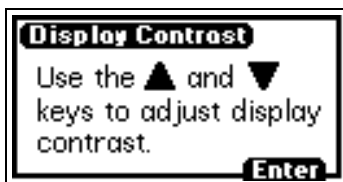

Use the ▲ and ▼ keys to adjust the contrast of the display.

## Displaying system info

The System Info key (Shift 4) displays information about the detector, including the serial number, the software version number, and the IEEE address, if applicable.

## Optimizing performance

---

You can adjust the noise level, peak height, peak direction, and the temperatures of the internal oven and column heaters to optimize the performance of the detector. This section provides guidelines and considerations for selecting these parameter values best suited to your application:

- RIU-FS or Sensitivity (Home 2)
- Filter Type and Time constant (Home 2)
- Temperature
- Polarity (+/- key)

## Attenuation/sensitivity guidelines

Attenuation/sensitivity affects the magnitude of the output signal to an integrator. Increasing the attenuation/sensitivity setting increases the resulting peak areas, but it also increases baseline noise and the response to environmental fluctuations. In addition, an increase in attenuation/sensitivity reduces the dynamic range over which the refractometer output is useful. The following figures show examples of the effects of varying the attenuation/sensitivity setting on a chromatogram and of the effects of varying the filter time setting on a chromatogram

## Effects of attenuation/sensitivity settings

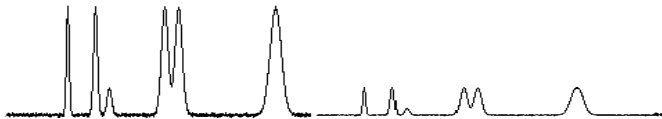

RIU mode → RIU-FS = 156

RIU-FS = 625

410 mode → Sens = 64

Sens = 16

## Effects of filter time constant settings

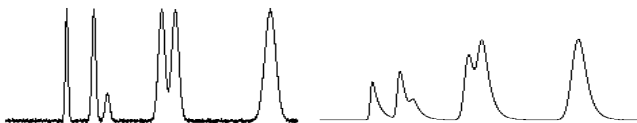

Low filter  
time constant  
setting

High filter  
time constant  
setting

## Temperature

These screens control the internal detector oven and, if configured, Waters column heater module. These screens are the same for RIU and 410 modes.

### Temperature screen 1



## Temperature screen 2

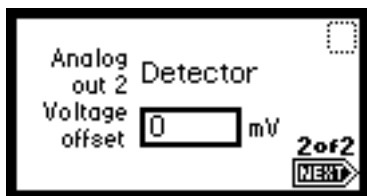

### Det

You can set the temperature of the detector oven in the range of 30 to 55 °C. The detector will then try to achieve and maintain that temperature, using a resistive heating element under software control. Actual temperature can differ from the setpoint, particularly after making a change to the setpoint. The user interface displays both setpoint and actual temperatures.

Under Empower or Millennium<sup>32</sup> control or Alliance or 600 PowerLine-based systems, the upper temperature limit is 50 °C.

### Col

The temperature of the column heater connected to the column heater module port on the rear panel can be set in the range ambient 5 to 150 °C. The 2414 detector, which has access to the column heater module temperature sensor, will then try to achieve and maintain the setpoint temperature, sending control signals to the external hardware. Actual temperature can differ from the setpoint, particularly after a change to the setpoint has been made. The user interface displays both set point and actual temperatures.

### Aux

Auxiliary output channel is provided on the rear panel, and is under the control of the software. The signal source for the channel is user programmable.

When the Detector Oven Temperature channel output type is selected, the channel will output a 0- to 2-V signal on Auxiliary Output Channel that corresponds to:

$$\text{AUX OUT} = (1\text{V} / 100 \text{ }^\circ\text{C})$$

When the Column Heater Module Temperature channel output type is selected, the channel will output a 0 to 2 Volt signal on Auxiliary Output Channel that corresponds to:

$$\text{AUX OUT} = (1\text{V} / 100\text{ }^{\circ}\text{C})$$

Voltage offset – This parameter, expressed in mV, is used to shift the auxiliary out from the analog output in a positive or negative direction. This is used to null any offsets between the 2414 detector and a connected chart recorder or data system. The offset is added after any polarity has been applied to the output (default is 0 mV).

## Operating the trace and scale functions

The Trace function allows you to display a trace for the last  $n$  minutes (up to 60) of detector operation.

When you press the TRACE key, the detector displays the RIU acquired over the last 30 minutes by default. It updates the trace once every 20 seconds.

When you press the Scale key (Shift TRACE), the detector displays the scaled trace with T1 (ending time) displayed (–30 for the last 30 minutes) by default.

You can change the ending time parameter to any number from 1 to 60. You can use the Scale function to “zoom” in on a particular section of the trace.

### To display the Scale parameters after you press the Scale key

1. Press Next to display T2 (starting time). The default is 0.
2. Press Next again to display RIU1 (starting or low refractive index change). The default is auto.
3. Press Next again to display RIU2 (ending or high refractive index change). The default is auto.

By entering appropriate times and refractive index change numbers in the four scaling parameter boxes, you can zoom in on one section of the current refractive index change trace.

- For RIU1 and RIU2, press CE to reset to auto.
- T1 represents the left side of the trace, or ending time to be displayed (default is –30).
- T2 represents the right side of the trace, or starting time (default is 0).

The following figure shows a 10-minute trace of continuous 200  $\mu$ RIU peaks.

**Scaled trace of continuous peaks with T1 changed to -10**

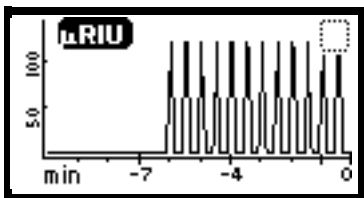

The following figure shows a 5-minute scaled trace (or zoom) of the 10 minutes of continuous injections. T1 is changed to -5.

**Scaled trace for 5 minutes of continuous peaks with t1 changed to -5**

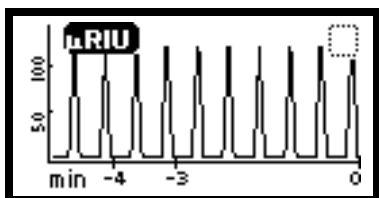

As you modify the output using the Scale function, the Trace function continues to display the detector output in real time.

## Powering-off

---

**Recommendation:** Do not power-off the detector unless you are storing it.

If you are not storing the detector, set the flow rate to 0.1 mL/min, and keep the pump or solvent delivery system operating to minimize the amount of time the detector needs for reequilibration when you use it again.

## Removing buffered mobile phase

**To remove mobile phase from the fluid path of the 2414 detector**

1. Replace the buffered mobile phase with 100% HPLC-quality water and flush the system for 10 minutes at 2 mL/min.

2. Replace the 100% water mobile phase with a solution of 90% methanol:10% water, and flush the system for 10 minutes at 2 mL/min.



**Caution:** If your storage solvent is incompatible with your column, remove the column before flushing.

Follow the recommended procedures for injector purging and priming for the pump in use with your HPLC.

Power-off any peripheral devices before shutting down the detector. To power-off the detector, press the on/off switch located at the lower-right front corner of the unit.



# 6

## Maintenance Procedures

### Contents

| Topic                          | Page |
|--------------------------------|------|
| Decontaminating the fluid path | 6-2  |
| Replacing fuses                | 6-4  |

Detector maintenance involves cleaning the fluid path and replacing fuses.



**Warning:** To avoid electrical shock,

- do not open the detector's cover. The detector's components are not user-serviceable.
- do not disconnect an electrical assembly while the detector is powered-on.



**Warning:** When you handle solvents, change tubing, or operate the detector, always observe Good Laboratory Practices (GLP). Know the physical and chemical properties of the solvents you use by referring to their Material Safety Data Sheets.



**Warning:** To avoid damage caused by static electricity, do not touch integrated circuit chips or other components that do not specifically require manual adjustment.

## Decontaminating the fluid path

---

A contaminated fluid path can cause baseline noise, drift, inaccurate sample refraction, and other operational problems. If you suspect the detector's fluid path is contaminated, follow the procedure, below, to decontaminate it.

### Required materials

- A wrench suitable for removing and replacing the column
- A solvent miscible in both the mobile phase and water (methanol is commonly used)
- HPLC-grade water
- A strong cleaning solvent suitable for your system (6N nitric acid is commonly used)

- A separate waste container for acid waste
- If you use an acid as a cleaning solvent, a means of measuring the pH of the acid effluent



**Caution:** If you use 6N nitric acid and operate the detector at high sensitivities, flush the system extensively with water to remove all traces of the acid.

Avoid flushing nitric acid through the reference flow cell.

### To decontaminate the fluid path



**Warning:** Strictly adhere to the following procedure.

1. Stop the pump or solvent delivery system, and replace the column with a union.
2. Replace the mobile phase with an intermediary solvent miscible in both the current solvent and water.
3. Set the detector to purge mode for approximately 5 minutes, and run for an additional 5 minutes in normal mode.
4. Restart the pump or solvent delivery system, and then set the flow rate to 5 mL/min, maintaining the purge for at least 5 minutes.
5. Switch the pump or solvent delivery system to HPLC-grade water, and flush the detector for 10 minutes.



**Warning:** Provide a separate, clean, waste container for the cleaning solution. Do not allow organic waste to mix with acid waste.

6. Switch the pump or solvent delivery system to the cleaning solvent, and flush the detector for 10 minutes.
7. Switch the pump or solvent delivery system back to HPLC-grade water and flush until the pH of the waste effluent is neutral (a pH value of 6.0 to 7.0).
8. Switch the pump or solvent delivery system back to the water-miscible intermediate solvent, and flush for 10 minutes.

9. Switch the pump or solvent delivery system back to the mobile phase, and flush for 5 minutes.
10. Take the detector out of purge mode and stop the pump or solvent delivery system.
11. Reattach the column and reequilibrate the detector.

## Replacing fuses

---

### Required item

- Flat-blade screwdriver
- Replacement fuse: F 3.15 A, 250 V

### Identifying a faulty fuse

Suspect a faulty fuse if you encounter any of these problems:

- The detector fails to power-on.
- The display is blank.
- The cooling fan does not operate.

You can usually identify a faulty, or open, fuse by its smoked glass or broken filament. Nevertheless, a fuse can be faulty even when such signs are not visible. In those cases, must remove the fuse and test it for electrical continuity.

For information on detecting the cause of a blown fuse, refer to [“Hardware troubleshooting” on page 7-15](#).

### To replace the fuse



**Warning:** To avoid electrical shock, power-off and unplug the detector before examining the fuse. For continued protection against fire, replace the fuse only with another of the same type and rating.

1. Power-off the detector, and disconnect the power cable from the rear panel.
2. Release the fuse holder squeezing together its two tabs.

3. Pull the fuse holder, applying minimal force to remove it from the rear panel.

### Removing and replacing the fuse

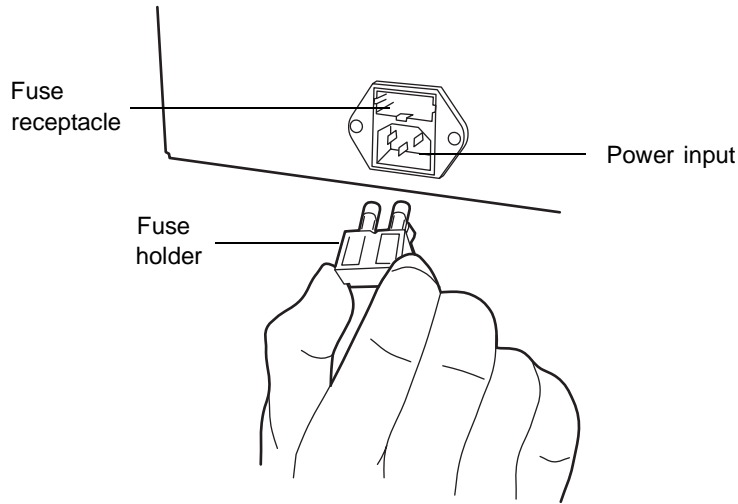

4. Remove and discard the old fuse.
5. Make sure that the new fuse is properly rated for your requirements.



**Warning:** To avoid fire, replace the fuse only with another of the same type and rating.

### Fuse requirements

| Nominal voltage    | Frequency | Required fuse   |
|--------------------|-----------|-----------------|
| 100 VAC to 250 VAC | 50/60 Hz  | F 3.15 A, 250 V |

6. Insert the new fuse into the fuse holder.
7. Insert the fuse holder into its receptacle in the detector's rear panel, and gently push on the fuse until it locks into position.



# 7 Error Messages, Diagnostic Functions, and Troubleshooting

Consult this chapter when diagnosing problems with your 2414 detector. Because the detector measures bulk properties of the system the source of an apparent detector problem can lie with the chromatography itself or the other instruments in your system.

If you suspect that a problem is a general chromatography problem, refer to [“Chromatography troubleshooting” on page 7-16](#).

## Contents

| Topic   | Page |
|---|------|
| <a href="#">Error messages</a>                  | 7-2  |
| <a href="#">Performing diagnostic functions</a> | 7-6  |
| <a href="#">Troubleshooting</a>                 | 7-14 |

## Error messages

---

The detector can display two types of error messages:

- Messages requiring you to recycle power, and then contact Waters Technical Service if the error persists (see [“Accessing the diagnostic functions” on page 7-6](#)). Most errors in this category are encountered on startup.
- Messages requiring you to perform a specific corrective action. These can appear at startup and during operation.

### Startup error messages

Startup diagnostic routines run automatically when you power-on the detector. These diagnostic routines verify the proper operation of the detector electronics. If one or more of the startup diagnostic tests fail, the detector beeps and displays an error message.

**Note:** To help avoid errors at startup, confirm that the flow cell contains fresh degassed solvent and no air bubbles.

#### Initialization screen



The following table contains startup error messages, descriptions, and recommended actions you can take to diagnose and correct the problem.

#### Startup error messages

| Error message                | Description                 | Corrective action   |
|------------------------------|-----------------------------|---|
| Instrument didn't initialize | Startup diagnostics failure | Recycle power to the detector. If the error persists, contact Waters Technical Service. |



## Startup error messages (Continued)

| Error message               | Description   | Corrective action  |
|-----------------------------|---|--|
| No Purge Valve Detected     | Purge valve not present or detected                   | Recycle power to the detector, and examine the purge valve. If the error persists, contact Waters Technical Service. |
| No source LED detected      | LED is defective                                      | Recycle power to the detector. If the error persists, contact Waters Technical Service.                              |
| Non-volatile RAM Corrupted  | RAM Startup test failure, RAM is corrupted            | Recycle power to the detector. If the error persists, contact Waters Technical Service.                              |
| Factory Default Set         | RAM is corrupted                                      | Recycle power to the detector. If the error persists, contact Waters Technical Service.                              |
| Invalid Valve Configuration | Valves improperly configured                          | Contact Waters Technical Service.  |
| Pre-amp Communication       | Startup test failure                                  | Recycle power to the detector. If the error persists, contact Waters Technical Service.                              |
| RTD missing or defective    | Internal over temperature sensor missing or defective | Recycle power to the detector. If the error persists, contact Waters Technical Service.                              |

## Operational error messages

When you encounter an error message, use the enter key to clear the message and continue operating the detector following any recommended corrective action.

**Tip:** When you encounter a fatal error (see the table below), ensure that the detector's flow cell is clean, filled with fresh mobile phase, and contains no air

bubbles before you recycle power. If the error persists, contact Waters Technical Service.

### Error messages preventing operation

| Error message                | Description            | Corrective action  |
|------------------------------|------------------------|--|
| System cannot respond        | Fatal error            | Recycle power to the detector. If the error persists, contact Waters Technical Service.  |
|                              | LED intensity too low  | Purge the detector and run the optimize LED diagnostic function. If the error persists, contact Waters Technical Service.                  |
|                              | LED intensity too high | Purge the detector and run the optimize LED diagnostic function. If the error persists, contact Waters Technical Service.                  |
| Method not found             | RAM is corrupted       | Recycle power to the detector. If the error persists, contact Waters Technical Service   |
| Configuration error          | RAM is corrupted       | Recycle power to the detector. If the error persists, contact Waters Technical Service   |
| Acquisition parameters error | RAM is corrupted       | Recycle power to the detector. If the error persists, contact Waters Technical Service   |
| Auto Zero offset excessive   | Value out of range.    | Verify or clear the auto zero offset in diagnostics, and then purge the detector. If the error persists, contact Waters Technical Service. |

## Error messages preventing operation (Continued)

| Error message                                     | Description   | Corrective action  |
|---|---|--|
| Rear panel Purge Valve Asserted                   | Signal to Purge External Event detected                         | Clear error message.   |
| Rear panel Recycle Valve Asserted                 | Signal to Recycle External Event detected                       | Clear error message.   |
| Instrument Mode changed to 410 mode               | Informs user that configuration has changed                     | Clear error message.   |
| Oven temperature set point has not been reached   | Allow internal oven temperature to come to temperature          | Verify external room temperature is not a factor. If the error persists, contact Waters Technical Service. |
| Column temperature set point has not been reached | Allow external column heater temperature to come to temperature | Verify external room temperature is not a factor. If the error persists, contact Waters Technical Service. |
| Detector Oven under temp                          | Allow internal oven temperature to come to temperature          | Verify external room temperature is not a factor. If the error persists, contact Waters Technical Service. |
| Detector Oven over temp                           | Check internal oven temperature parameters                      | Verify external room temperature is not a factor. If the error persists, contact Waters Technical Service. |
| Detector Oven over absolute limit                 | Detector oven or control is defective                           | Recycle power to the detector. If the error persists, contact Waters Technical Service.                    |

## Error messages preventing operation (Continued)

| Error message                              | Description   | Corrective action   |
|--|---|---|
| External Column Heater under temp          | Allow external column heater temperature to come to temperature | Recycle power to the detector. If the error persists, contact Waters Technical Service.   |
| External Column Heater over temp           |   | Verify external column heater temperature parameters, and recycle power to the detector. If the error persists, contact Waters Technical Service.     |
| External Column Heater over absolute limit | External column heater or control is defective                  | Recycle power to the detector. If the error persists, contact Waters Technical Service.   |
| External Column Heater not detected        |   | Inspect the external column heater module cable connection and verify that it is powered-on. If the error persists, contact Waters Technical Service. |

## Performing diagnostic functions

---

The detector runs both user-selectable and service diagnostic tests. You access the user diagnostic tests by pressing the DIAG key. Only qualified Waters service personnel can access service diagnostics. To exit any diagnostic when completed, press DIAG to return to the diagnostics choice list or HOME to return to the Home screen.

## Accessing the diagnostic functions

You can use several diagnostic functions to troubleshoot and verify the proper operation of the detector electronics and optics.

## To access user-selectable diagnostic functions

1. Press the DIAG key on the detector's front panel.

**Result:** The detector displays the Diagnostics choice list.

### Diagnostics choice list

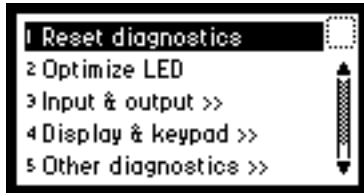

2. To access a specific diagnostic test, select the test you want to run, and press Enter, or press a number, from 1 to 6, that corresponds to the diagnostic number on the detector's keypad.

**Tip:** Choices that display other choices are indicated by >>.



Sticky diagnostic tests remain in effect until you disable them. When a sticky diagnostic test is active, the home screens display a wrench icon.

- You can disable a specific sticky diagnostic test by restoring its default settings.
- You can disable all active sticky diagnostic tests by pressing DIAG 1, Reset diagnostics.

If no sticky diagnostic tests are active, the wrench icon does not appear in the home screen. When you power-off the detector, all sticky diagnostics are disabled.

### Home screens, with active sticky diagnostic tests

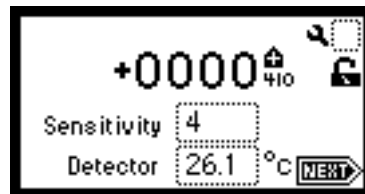
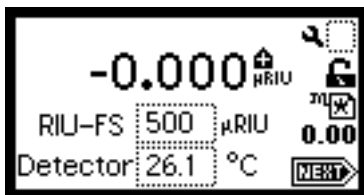

The user-selectable sticky diagnostic tests are:

- Fix (set) voltage output
- Simulate peak

**Note:** Running sticky diagnostic tests affects results. To clear changes to the voltage output, select 1, “Reset diagnostics”, from the diagnostics choice list, or recycle power to the detector.

The following table lists the diagnostics tests by their number on the choice list followed by a brief description.

### Detector diagnostics

| Diagnostic          | Description   |
|---------------------|---|
| Reset Diagnostics   | Resets all tests to their defaults. Removes sticky diagnostic tests and wrench icon.  |
| Optimize LED        | Allows user to view LED Type and LED energy and to initialize automatic optimization procedure.   |
| Input & Output      | List of tests to control contact closure inputs and single switch output:<br><ol style="list-style-type: none"> <li>1. Fix Voltage</li> <li>2. Switches &amp; Events</li> <li>3. Previous choices</li> </ol>  |
| Display & Keypad    | List of tests for display and keypad:<br><ol style="list-style-type: none"> <li>1. Test Keypad</li> <li>2. Test Display</li> <li>3. Previous choices</li> </ol>   |
| Other Diagnostics   | Miscellaneous tests and functions revealing the view auto zero offset, oven and external column heater configuration and status, generate test peaks, check purge and recycle valve status and operation.<br><ol style="list-style-type: none"> <li>1. Autozero offset</li> <li>2. Oven/column heater</li> <li>3. Simulate Peak</li> <li>4. Valve</li> <li>5. Previous choices</li> </ol> |
| Service Diagnostics | Diagnostics used by Waters service personnel  |

## Using the Optimize LED diagnostic function

To use the Optimize LED diagnostic function, press DIAG 2.

This diagnostic function displays the type of LED used (880nm) and automatically sets the energy level of the internal LED. An error message appears if the energy level is too high or too low. This message commonly appears when the detector was purged recently or is about to begin a new analysis, or when a mobile phase composition change affects the flow cell. The LED level can change if the temperature of the internal oven changes.

### Optimize LED screen

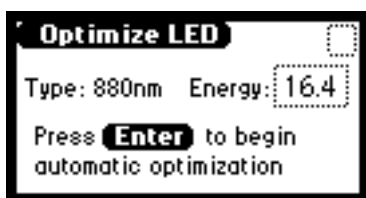

## Using the input and output diagnostic functions

Use the input and output diagnostic functions to perform these tasks:

- Fix (that is, specify) voltage
- Monitor event-out switch and eight contact closure event inputs

To access either of the input and output diagnostic functions, press DIAG 3, Input & output.

### Input & output diagnostics screen

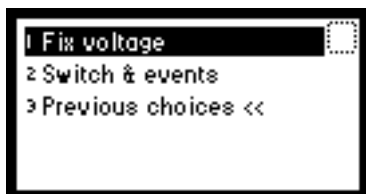

## Specifying fixed voltage output

From the Input & output choice list, press 1, Fix voltage, to select a voltage for the detector output and auxiliary output.

**Requirement:** Both voltages must be fixed, but you can set the values differently. Set the voltage for both output channels from  $\pm 2000$  mV in range. The voltage is driven on the selected channel (Detector Out or Auxiliary Out).

## Monitoring contact closures and setting switches

### To monitor the contact closures and control switch output

1. On the Input & output choice list, press 2, Switch & events, to monitor the eight contact closure inputs and control the single switch output.

**Note:** The Input & output diagnostic function allows real-time monitoring of the state of the contact closure inputs. A solid (filled in) circle indicates the contact closure is closed (ON = High). An open (empty) circle indicates the contact closure is open (OFF = Low).

2. For the outputs (SW1), perform these steps:
  - a. Press Enter to display the active switch (surrounded by a dotted-line border).
  - b. Press any numerical key to change the status of the switch (from ON to OFF or vice versa).

### Switch & Events display screen





## Display and keypad diagnostic tests

To access the display and keypad diagnostic tests, press DIAG 4.

### Test display diagnostic test

#### To run the test display test

1. From the Display & keypad choice list, press 2, Test display.  
**Result:** When you press 2, the display fills from top to bottom and from right to left, and then the Display & keypad choice list appears. If the display does not completely fill horizontally or vertically, contact your Waters service representative.
2. From the Display & keypad choice list, press 3 to return to the diagnostics choice list.

### Test keypad diagnostic test

#### To run the test keypad test

1. From the Display & keypad choice list, press 1, Test keypad.  
**Result:** A bitmap representation of the keypad appears.

#### Test Keypad diagnostic screen

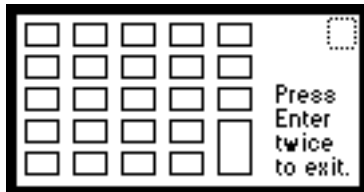

2. Press any key to begin the test, and then press each key until you pressed all of them.  
**Result:** When the keypad is operating properly, each key location is filled in and then cleared with another press of the key. If any key does not respond when pressed, contact your Waters service representative.  
**Requirement:** Press Enter twice to exit the keypad diagnostic.

## Using the Other diagnostic functions

The Other diagnostics menu provides four additional diagnostic functions:

- Auto zero offsets – Use this diagnostic function to display the auto zero offset.
- Oven/Column Heater – Use this diagnostic function to display the internal oven and, if any, the column heater status.
- Simulate peak – Use this diagnostic function to specify the generation of test peaks to calibrate your integrator or data system.
- Valve – Use this diagnostic function to monitor the status of the event inputs and single event output switch.

To access these diagnostic functions, press DIAG 5, Other diagnostics.

### Displaying Auto Zero Offset

From the Other diagnostics choice list, press 1, Auto Zero offsets.

**Note:** You can also use this diagnostic function to display and reset the auto zero offset, in both 410 or RIU modes, to zero by pressing Cancel (Shift 0).

### Oven/column heater

From the Other diagnostics choice list, press 2, Oven/column heater.

**Note:** You can also use this diagnostic function to display the internal oven and external column heater (if configured) status. The heater icon flashes to indicate that the internal oven is enabled. The % Duty indicates whether the oven is still working to attain the temperature set point (an elevated value) or has reached equilibrium (a lower value). The oven actual temperature and its set point is displayed. You can edit the set point in this screen. The presence or absence of an external column heater module is also indicated.

### Simulate peak

From the Other diagnostics choice list, press 3, Simulate peak to generate test peaks on the chart, trace, or other output.

**Note:** When the simulate peak diagnostic function is enabled, the wrench icon appears in the home screen.

## To specify the exact peaks

1. Enter a peak height, in  $\mu$ RIU, from 1 to 999.  
**Note:** In 410 mode, the peak height is converted from RIU to the corresponding value, depending on the sensitivity setting.
2. Enter a peak width in seconds.  
**Requirement:** The width must be greater than 0 or less than or equal to the period of peak repetition.
3. Enter a period for repeating the peaks, in seconds, from 1 to 99.
4. Press the Run key. The generation of the peaks is indicated by the real-time display of the change in peak height in  $\mu$ RIU within the simulate peak diagnostic window.
5. Press Run/Stop to disable peak generation.

The detector generates the peaks on the trace, chart, or data system display until you disable the Simulate peak diagnostic function. The amplitude of the test peaks is affected by your choice of filter time constant.

When it is enabled, the choice list changes to read “Disable test peaks”. To disable this diagnostic, press 1, “Disable test peaks from the other diagnostics choice list”, or press Run/Stop.

## Valve

From the other diagnostics choice list, press 4, Valve, to display status of the purge and recycle valves.

**Note:** This diagnostic function also allows you change or test the on/off position in both the purge and recycle valves.

## Purge and Recycle Valve screen



## Troubleshooting

---

This section provides some causes of errors and recommended troubleshooting actions for the detector hardware and chromatography. Keep in mind that the source of apparent detector problems can be within the chromatography or your other instruments as well as the 2414 detector.

Most detector problems are relatively easy to correct. If you are unable to correct a problem or a failed condition, contact Waters Technical Service.

### When you contact Waters

To expedite your request for service, have the following information available when you call Waters Technical Service:

- 2414 detector serial number
- Problem symptom(s)
- RIU-FS or measurement range in RIU mode, or sensitivity setting in 410 mode
- Internal oven temperature
- Flow rate
- Filter setting
- Type of column, column temperature setting
- Operating pressure
- Solvent(s)
- System configuration (other components)

### Diagnostic tests and error messages

You can select diagnostic tests to help you troubleshoot basic system problems. Refer to [“Performing diagnostic functions” on page 7-6](#), for diagnostic test descriptions and instructions on how to use them.

Error messages that can appear as you start up or operate the detector and suggested corrective actions appear in the tables on [page 7-2](#) and [page 7-4](#).

**Note:** Power surges, line spikes, and transient energy sources can adversely affect detector operations. Be sure that the detector’s electrical supply is properly grounded and free from any of these conditions.

## Hardware troubleshooting

The following table describes hardware troubleshooting for the detector.

### General system troubleshooting

| Symptom                                 | Possible cause   | Corrective action  |
|---|--|--|
| Detector inoperative                    | Fuse blown   | Verify the front panel display is operational; if it is not, replace the AC rear panel fuse              |
|   | No power at outlet   | Verify outlet by connecting another electrical unit known to be in working order and see if it operates. |
| Front panel display fails to illuminate | Broken electrical connection   | Inspect electrical connections.  |
|   | Fuse blown   | Inspect and, if necessary, replace fuse(s).  |
|   | Bad LCD or control board   | Contact Waters Technical Service.  |
| Front panel displays odd characters     | Faulty EPROMs<br>Bad LCD control board                                       | Contact Waters Technical Service.  |
| IEEE-488 problems                       | IEEE-488 410 mode configuration disabled and/or IEEE address set incorrectly | Set the configuration page correctly.  |
|   | Bad IEEE-488 cable   | Check the IEEE-488 cable. Replace the IEEE-488 cable.  |
| Keypad not functioning                  | Keypad defective   | Recycle power to the 2414 detector and run the keypad diagnostic. Contact Waters Technical Service.      |
| Analog output incorrect                 | RIU-FS setting changed   | Reset the RIU-FS setting in RIU mode.  |

## Chromatography troubleshooting

This section provides chromatography troubleshooting information that you can use to isolate and correct the possible causes of problems related to these issues:

- Abnormal baseline (drift, noise, or cycling) (see the table on [page 7-17](#)).
- Erratic or incorrect retention times (see the table on [page 7-22](#)).
- Poor peak resolution (see the table on [page 7-24](#)).
- Incorrect qualitative/quantitative results (see the table on [page 7-25](#)).



**Warning:** To avoid chemical hazards, always observe Good Laboratory Practices when handling solvents and performing maintenance. Refer to the Material Safety Data Sheets for the solvents in use.

If your system is exhibiting symptoms not addressed in one of the following tables, refer to [“Troubleshooting” on page 7-14](#). If you need further help, contact Waters Technical Service.

### Abnormal baseline

Drift, noise, and cycling are common symptoms of an abnormal baseline.

**Baseline drift** – Can be flow-related or result from changing ambient conditions, especially temperature. Determine if drift is flow related by shutting down the solvent delivery system or pump.

**Noise** – If baseline noise is high, determine whether it is a short- or long-term variation. You can eliminate many possible causes of baseline noise by identifying the rate at which the baseline is changing and purging the flow cell with the proper solvent.

**Cycling** – If the baseline is cycling, determine the period of the cycling and if it is related to the flow rate or fluctuations in ambient temperature or pressure.

Use the following table to troubleshoot baseline problems.

### Abnormal baseline troubleshooting

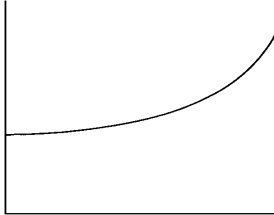
| Symptom  | Possible cause                                      | Corrective action   |
|--|---|---|
| Baseline drift, rapid<br> | Column not equilibrated                             | Equilibrate column.   |
|  | Detector not allowed to warm up                     | Allow detector to warm up until baseline is stable. Warmup time varies based on sensitivity.          |
|  | Solvent contaminated or not HPLC grade              | Use fresh solvent.  |
|  | Solvent not properly degassed (rapid or slow drift) | Degas the solvent. Cap the solvent reservoir.   |
|  | Flow cell can possibly contain an air bubble        | Properly purge the system.  |
|  | Tubing contaminated                                 | Clean the tubing using the procedure in <a href="#">“Decontaminating the fluid path” on page 6-2.</a> |
|  | Flow fluctuations (rapid or slow drift)             | Fix pump problems, replace pump seals, check valves.  |
|  | Improper ambient environment                        | Verify and correct ambient temperature and humidity   |

## Abnormal baseline troubleshooting (Continued)

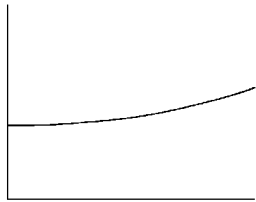
| Symptom   | Possible cause                               | Corrective action  |
|---|--|--|
| Baseline drift, slow<br><br> | Solvent contaminated                         | Use fresh, degassed solvent.   |
|   | Ambient temperature fluctuations             | Stabilize operating environment temperature enough to allow full equilibration. Keep the system away from air conditioning vents, chance breezes, and direct sunlight. |
|   | Flow cell can possibly contain an air bubble | Properly purge the system.   |
|   | Dirty flow cell                              | Clean flow cell (see <a href="#">“Decontaminating the fluid path” on page 6-2</a> ).   |
| Baseline drift, descending  | Leaky flow cell                              | Call Waters Technical Service.   |
|   | Flow cell can possibly contain an air bubble | Properly purge the system.   |

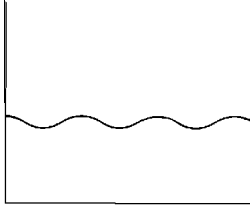

## Abnormal baseline troubleshooting (Continued)

| Symptom  | Possible cause                                      | Corrective action  |
|--|---|--|
| <p>Short-term noise cycling<br/>(30 sec to 60 sec)</p>  | Pump pulsing  | Add pulse dampener and shut off flow to confirm if this is the cause.  |
|  | Inadequate solvent blending in pump                 | Connect high-flow pulse dampener. Use gradient mixer.  |
|  | Flow cell can possibly contain an air bubble        | Properly purge the system.   |
|  | Flow fluctuating                                    | Stabilize flow (see pump operator's manual).   |
|  | Solvent not mixed (short- or long-term cycling)     | Stir the solvent.  |
|  | Faulty check valve                                  | Clean/replace/rebuild pump check valves.   |
|  | AC power source (short- or long-term cycling)       | Disconnect other instruments on the electrical circuit; use a different wall outlet; determine the suitability of the line voltage; use power conditioner. |
|  | Radio frequency noise (short or long-term cycling)  | Eliminate interference.  |
| Improper ambient environment   | Verify and correct ambient temperature and humidity |  |

## Abnormal baseline troubleshooting (Continued)

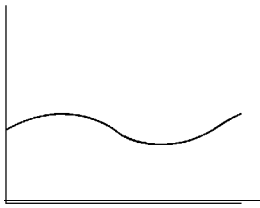
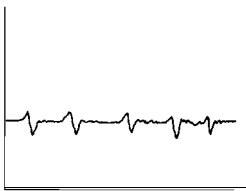
| Symptom  | Possible cause  | Corrective action  |
|--|---|--|
| <b>Long-term noise cycling (approximately 1 hour)</b><br> | Ambient temperature fluctuations  | Stabilize ambient temperature.   |
|  | Integrator or recorder faulty   | Examine integrator or recorder for excessive baseline noise.           |
|  | Faulty check valve  | Clean/replace/rebuild pump check valves.                               |
|  | Flow cell can possibly contain an air bubble  | Properly purge the system.   |
| <b>Baseline noise, random</b><br>                         | Flow cell can possibly contain an air bubble  | Properly purge the system.   |
|  | Solvents not properly degassed  | Degas solvents (see <a href="#">“Solvent degassing” on page 4-5</a> ). |
|  | Flow erratic, pump not primed   | Prime the pump.  |
|  |   | Inspect for air in the pump, replace failing seals.                    |
|  | Solvents contaminated   | Use fresh solvent.   |
|  | Column contaminated   | Clean/replace column.  |
| Dirty flow cell  | Clean fluid path (see <a href="#">“Decontaminating the fluid path” on page 6-2</a> ). |  |

## Abnormal baseline troubleshooting (Continued)

| Symptom                               | Possible cause  | Corrective action   |
|---------------------------------------|---|---|
| Baseline noise, random<br>(Continued) | Analog output cable not properly connected between 2414 and data system or recorder | Properly connect cable.                                     |
|                                       | System improperly grounded  | Plug into different outlet on different electrical circuit. |
|                                       |   | Use power conditioner.                                      |
|                                       | Recorder voltage incorrect  | Set recorder to correct voltage.                            |
| Radio frequency noise                 | Eliminate interference.   |   |

## Erratic or incorrect retention times

When you troubleshoot retention time problems, first determine whether the retention times follow any of these patterns:

- They change from run to run or show consistency from run to run, but nevertheless fall outside the allowable range for the assay
- They correlate with pressure fluctuations that are shortterm (with each pump cycle) or longterm (over the course of several minutes)
- They correlate with absolute pressure changes; that is, pressure is constant but higher or lower than the normal operating pressure
- They change suddenly at the end of a series of runs (which can indicate that air is dissolving in the mobile phase, that the mobile phase is degrading, or that the column is contaminated)
- They change early in a series of runs and tend to become constant or within range within 4 minutes (which can indicate that the column was not equilibrated, or that the solvent is not properly degassed)

Use the following table to troubleshoot problems with retention times.

### Troubleshooting problems with retention times

| Symptom                   | Possible cause                     | Corrective action   |
|---------------------------|------------------------------------|---|
| Erratic retention times   | Air bubble in pump head            | Degas all solvents, prime pump (see <a href="#">“Solvent degassing methods”</a> on page 4-6). |
|                           | Malfunctioning pump check valves   | Inspect and clean/replace/rebuild pump check valves.  |
|                           | Leaking pump seals                 | Replace pump seals.   |
|                           | Separation chemistry               | Verify mobile phase and column.   |
|                           | Clogged solvent filters            | Replace filters.  |
| Increased retention times | Incorrect flow rate                | Verify flow rate.   |
|                           | Incorrect solvent composition      | Change solvent composition.   |
|                           | Column heater module not on        | Power-on column heater module.  |
|                           | Column not equilibrated            | Equilibrate column.   |
|                           | Incorrect column or guard column   | Use correct column or guard column.   |
| Doubled retention times   | Air bubble in pump head            | Prime pump to remove bubble.  |
|                           | Malfunctioning pump check valve(s) | Inspect and clean/replace/rebuild pump check valve(s).  |
|                           | Broken pump plunger                | Replace the plunger.  |

## Troubleshooting problems with retention times (Continued)

| Symptom                 | Possible cause                   | Corrective action   |
|-------------------------|----------------------------------|---|
| Reduced retention times | Incorrect flow rate              | Verify flow rate.   |
|                         | Incorrect solvent composition    | Change composition.   |
|                         | High column temperature          | Reduce column temperature.  |
|                         | Incorrect column pretreatment    | See column manual.  |
|                         | Column contaminated              | Clean/replace column.   |
|                         | Incorrect column or guard column | Use correct column or guard column.   |
| Reproducibility errors  | Solvent not properly degassed    | Degas solvent (see <a href="#">“Solvent degassing methods” on page 4-6</a> ). |
|                         | Incorrect chemistry/integration  | Check chemistry/integration.  |
|                         | Column not equilibrated          | Equilibrate column  |
|                         | Injector problem                 | Troubleshoot injector.  |

## Poor peak resolution

Before you address peak resolution problems, be certain that peaks elute at the correct retention time. The most common causes of poor peak resolution can also cause retention time problems.

If peak retention times are correct, determine whether poor resolution occurs throughout the chromatogram or at a single peak pair.

If efficiency of early peaks is poor, extra-column band broadening, such as auto injector or guard column failure, can be the cause. If peak efficiency is poor throughout the chromatogram, post-column band-broadening or loss of column efficiency can be the cause.

If only one peak in a chromatogram is badly-shaped, the peak component can possibly be interacting with the column through a chemical mechanism that does not affect the components in the other peaks. Troubleshooting this resolution problem requires an understanding of the separation chemistry.

Use the following table to troubleshoot peak resolution problems that are affecting your results.

### Resolution troubleshooting

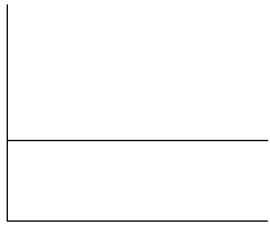
| Symptom  | Possible cause   | Corrective action  |
|--|--|--|
| Straight baseline, no peaks<br> | No pump flow   | Set pump flow rate.  |
|  | LED not on   | Call Waters Technical Service.   |
|  | Detector not zeroed<br>Improper connection between detector and recorder | Auto zero detector baseline.<br>Inspect cabling between unit and recorder.   |
|  | Solvent and sample have similar refractive indices                       | Select another solvent.  |
|  | Sensitivity too low  | Select higher sensitivity.   |
|  | No sample injected   | Inspect injector.  |
|  | Leak in solvent path   | Inspect fittings and drip tray.  |
|  | Bad flow cell  | Inspect and clean/flush flow cell.<br>Call Waters Technical Service.         |
|  | Bad column   | Inspect and clean/flush or replace column.<br>Call Waters Technical Service. |

## Resolution troubleshooting (Continued)

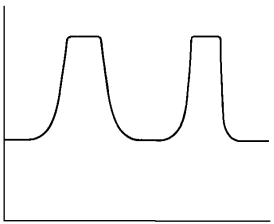
| Symptom  | Possible cause  | Corrective action   |
|--|---|---|
| Flat-topped peaks<br> | Detector not zeroed   | Auto zero detector baseline.  |
|  | Incorrect recorder input voltage  | Adjust recorder input voltage, or adjust detector output cable to correct position. |
|  | Sensitivity too high  | Select a lower sensitivity.   |
|  | Sample concentration or injection volume exceeds voltage output of detector | Decrease sample concentration or injection volume.                                  |

## Incorrect qualitative/quantitative results

If a peak is incorrectly identified by a data system or integrator, make sure that the retention times are correct.

If retention times are correct and peak resolution is good, the cause of qualitative and quantitative errors is not likely to be chromatographic. It is more likely the result of inadequate sample preparation or faulty processing of the data (integration).

Use the following table to troubleshoot problems with qualification and/or quantitation.

### Incorrect results troubleshooting

| Symptom               | Possible cause  | Corrective action      |
|-----------------------|---|------------------------|
| Decreased peak height | Leak in injector                                      | Troubleshoot injector. |
|                       | Degraded, contaminated, or improperly prepared sample | Use fresh sample.      |
|                       | Column contaminated                                   | Clean/replace column.  |
|                       | Loss of column efficiency                             | Clean/replace column.  |

## Incorrect results troubleshooting (Continued)

| Symptom         | Possible cause                      | Corrective action   |
|-----------------|-------------------------------------|---|
|                 | Change in mobile phase composition  | Correct mobile phase pH or ionic composition.   |
|                 | Incorrect flow rate                 | Change flow rate.   |
|                 | Dirty flow cell<br>Electronic noise | Clean the fluid path (see <a href="#">“Decontaminating the fluid path” on page 6-2</a> ). |
| Increased noise |                                     | Use the shortest cable lengths possible. Make sure cables are shielded.                   |
|                 | Dirty flow cell                     | Clean the fluid path (see <a href="#">“Decontaminating the fluid path” on page 6-2</a> ). |
|                 | Air bubble in flow path             | Replace column with union and purge flow path at 10 mL/min.                               |
|                 | Mobile phase not degassed           | Degas mobile phase.   |
|                 | Contaminated mobile phase           | Use fresh mobile phase.   |



# A Safety Advisories

Waters instruments display hazard symbols designed to alert you to the hidden dangers of operating and maintaining the instruments. Their corresponding user guides also include the hazard symbols, with accompanying text statements describing the hazards and telling you how to avoid them. This appendix presents all the safety symbols and statements that apply to the entire line of Waters products.

## Contents

| Topic   | Page                 |
|---|----------------------|
| <a href="#">Warning symbols</a>                               | <a href="#">A-2</a>  |
| <a href="#">Caution symbol</a>                                | <a href="#">A-4</a>  |
| <a href="#">Warnings that apply to all Waters instruments</a> | <a href="#">A-4</a>  |
| <a href="#">Electrical and handling symbols</a>               | <a href="#">A-11</a> |

## Warning symbols

---

Warning symbols alert you to the risk of death, injury, or seriously adverse physiological reactions associated with an instrument's use or misuse. Heed all warnings when you install, repair, and operate Waters instruments. Waters assumes no liability for the failure of those who install, repair, or operate its instruments to comply with any safety precaution.

### Task-specific hazard warnings

The following warning symbols alert you to risks that can arise when you operate or maintain an instrument or instrument component. Such risks include burn injuries, electric shocks, ultraviolet radiation exposures, and others.

When the following symbols appear in a manual's narratives or procedures, their accompanying text identifies the specific risk and explains how to avoid it.



**Warning:** (General risk of danger. When this symbol appears on an instrument, consult the instrument's user documentation for important safety-related information before you use the instrument.)



**Warning:** (Risk of burn injury from contacting hot surfaces.)



**Warning:** (Risk of electric shock.)



**Warning:** (Risk of fire.)



**Warning:** (Risk of needle puncture.)



**Warning:** (Risk of injury caused by moving machinery.)



**Warning:** (Risk of exposure to ultraviolet radiation.)



**Warning:** (Risk of contacting corrosive substances.)



**Warning:** (Risk of exposure to a toxic substance.)



**Warning:** (Risk of personal exposure to laser radiation.)



**Warning:** (Risk of exposure to biological agents that can pose a serious health threat.)

## Warnings that apply to particular instruments, instrument components, and sample types

The following warnings can appear in the user manuals of particular instruments and on labels affixed to them or their component parts.

### Burst warning

This warning applies to Waters instruments fitted with nonmetallic tubing.



**Warning:** Pressurized nonmetallic, or polymer, tubing can burst. Observe these precautions when working around such tubing:

- Wear eye protection.
- Extinguish all nearby flames.
- Do not use tubing that is, or has been, stressed or kinked.
- Do not expose nonmetallic tubing to incompatible compounds like tetrahydrofuran (THF) and nitric or sulfuric acids.
- Be aware that some compounds, like methylene chloride and dimethyl sulfoxide, can cause nonmetallic tubing to swell, which significantly reduces the pressure at which the tubing can rupture.

### Biohazard warning

This warning applies to Waters instruments that can be used to process material that might contain biohazards: substances that contain biological agents capable of producing harmful effects in humans.



**Warning:** Waters's instruments and software can be used to analyze or process potentially infectious human-sourced products, inactivated microorganisms, and other biological materials. To avoid infection with these agents, assume that all biological fluids are infectious, observe Good Laboratory Practices and, consult your organization's biohazard safety representative regarding their proper use and handling. Specific precautions appear in the latest edition of the US National Institutes of Health (NIH) publication, *Biosafety in Microbiological and Biomedical Laboratories* (BMBL).

## Chemical hazard warning

This warning applies to Waters instruments that can process corrosive, toxic, flammable, or other types of hazardous material.



**Warning:** Waters instruments can be used to analyze or process potentially hazardous substances. To avoid injury with any of these materials, familiarize yourself with the materials and their hazards, observe Good Laboratory Practices (GLP), and consult your organization's safety representative regarding proper use and handling. Guidelines are provided in the latest edition of the National Research Council's publication, *Prudent Practices in the Laboratory: Handling and Disposal of Chemicals*.

## Caution symbol

---

The caution symbol signifies that an instrument's use or misuse can damage the instrument or compromise a sample's integrity. The following symbol and its associated statement are typical of the kind that alert you to the risk of damaging the instrument or sample.



**Caution:** To avoid damage, do not use abrasives or solvents to clean the instrument's case.

## Warnings that apply to all Waters instruments

---

When operating this device, follow standard quality control procedures and the equipment guidelines in this section.



**Attention:** Changes or modifications to this unit not expressly approved by the party responsible for compliance could void the user's authority to operate the equipment.

**Important:** Toute modification sur cette unité n'ayant pas été expressément approuvée par l'autorité responsable de la conformité à la réglementation peut annuler le droit de l'utilisateur à exploiter l'équipement.

**Achtung:** Jedwede Änderungen oder Modifikationen an dem Gerät ohne die ausdrückliche Genehmigung der für die ordnungsgemäße Funktionstüchtigkeit verantwortlichen Personen kann zum Entzug der Bedienungsbefugnis des Systems führen.

**Avvertenza:** qualsiasi modifica o alterazione apportata a questa unità e non espressamente autorizzata dai responsabili per la conformità fa decadere il diritto all'utilizzo dell'apparecchiatura da parte dell'utente.

**Atencion:** cualquier cambio o modificación efectuado en esta unidad que no haya sido expresamente aprobado por la parte responsable del cumplimiento puede anular la autorización del usuario para utilizar el equipo.

**注意:** 未經有關法規認證部門允許對本設備進行的改變或修改,可能會使使用者喪失操作該設備的權利。

**注意:** 未经有关法规认证部门明确允许对本设备进行的改变或改装,可能会使使用者丧失操作该设备的合法性。

**주의:** 규정 준수를 책임지는 당사자의 명백한 승인 없이 이 장치를 개조 또는 변경할 경우, 이 장치를 운용할 수 있는 사용자 권한의 효력을 상실할 수 있습니다.

**注意:** 規制機関から明確な承認を受けずに本装置の変更や改造を行うと、本装置のユーザーとしての承認が無効になる可能性があります。



**Warning:** Use caution when working with any polymer tubing under pressure:

- Always wear eye protection when near pressurized polymer tubing.
- Extinguish all nearby flames.
- Do not use tubing that has been severely stressed or kinked.
- Do not use nonmetallic tubing with tetrahydrofuran (THF) or concentrated nitric or sulfuric acids.
- Be aware that methylene chloride and dimethyl sulfoxide cause nonmetallic tubing to swell, which greatly reduces the rupture pressure of the tubing.

**Attention:** Manipulez les tubes en polymère sous pression avec précaution:

- Portez systématiquement des lunettes de protection lorsque vous vous trouvez à proximité de tubes en polymère pressurisés.
- Éteignez toute flamme se trouvant à proximité de l'instrument.
- Évitez d'utiliser des tubes sévèrement déformés ou endommagés.
- Évitez d'utiliser des tubes non métalliques avec du tétrahydrofurane (THF) ou de l'acide sulfurique ou nitrique concentré.
- Sachez que le chlorure de méthylène et le diméthylesulfoxyde entraînent le gonflement des tuyaux non métalliques, ce qui réduit considérablement leur pression de rupture.

**Vorsicht:** Bei der Arbeit mit Polymerschläuchen unter Druck ist besondere Vorsicht angebracht:

- In der Nähe von unter Druck stehenden Polymerschläuchen stets Schutzbrille tragen.
- Alle offenen Flammen in der Nähe löschen.
- Keine Schläuche verwenden, die stark geknickt oder überbeansprucht sind.
- Nichtmetallische Schläuche nicht für Tetrahydrofuran (THF) oder konzentrierte Salpeter- oder Schwefelsäure verwenden.
- Durch Methylenchlorid und Dimethylsulfoxid können nichtmetallische Schläuche quellen; dadurch wird der Berstdruck des Schlauches erheblich reduziert.



**Attenzione:** fare attenzione quando si utilizzano tubi in materiale polimerico sotto pressione:

- Indossare sempre occhiali da lavoro protettivi nei pressi di tubi di polimero pressurizzati.
- Spegnere tutte le fiamme vive nell'ambiente circostante.
- Non utilizzare tubi eccessivamente logorati o piegati.
- Non utilizzare tubi non metallici con tetraidrofurano (THF) o acido solforico o nitrico concentrati.
- Tenere presente che il cloruro di metilene e il dimetilsolfossido provocano rigonfiamenti nei tubi non metallici, riducendo notevolmente la pressione di rottura dei tubi stessi.

**Advertencia:** se recomienda precaución cuando se trabaje con tubos de polímero sometidos a presión:

- El usuario deberá protegerse siempre los ojos cuando trabaje cerca de tubos de polímero sometidos a presión.
- Si hubiera alguna llama las proximidades.
- No se debe trabajar con tubos que se hayan doblado o sometido a altas presiones.
- Es necesario utilizar tubos de metal cuando se trabaje con tetrahidrofurano (THF) o ácidos nítrico o sulfúrico concentrados.
- Hay que tener en cuenta que el cloruro de metileno y el sulfóxido de dimetilo dilatan los tubos no metálicos, lo que reduce la presión de ruptura de los tubos.

**警告:** 當在有壓力的情況下使用聚合物管線時，小心注意以下幾點。

- 當接近有壓力的聚合物管線時一定要戴防護眼鏡。
- 熄滅附近所有的火焰。
- 不要使用已經被壓癟或嚴重彎曲管線。
- 不要在非金屬管線中使用四氫呋喃或濃硝酸或濃硫酸。
- 要了解使用二氯甲烷及二甲基亞楓會導致非金屬管線膨脹，大大降低管線的耐壓能力。



**警告:** 当有压力的情况下使用管线时, 小心注意以下几点:

- 当接近有压力的聚合物管线时一定要戴防护眼镜。
- 熄灭附近所有的火焰。
- 不要使用已经被压瘪或严重弯曲的管线。
- 不要在非金属管线中使用四氢呋喃或浓硝酸或浓硫酸。

要了解使用二氯甲烷及二甲基亚砜会导致非金属管线膨胀, 大大降低管线的耐压能力。

**경고:** 가압 폴리머 튜브로 작업할 경우에는 주의하십시오.

- 가압 폴리머 튜브 근처에서는 항상 보호 안경을 착용하십시오.
- 근처의 화기를 모두 끄십시오.
- 심하게 변형되거나 꼬인 튜브는 사용하지 마십시오.
- 비금속(Nonmetallic) 튜브를 테트라히드로푸란(Tetrahydrofuran: THF) 또는 농축 질산 또는 황산과 함께 사용하지 마십시오.

염화 메틸렌(Methylene chloride) 및 디메틸설폭시드(Dimethyl sulfoxide)는 비금속 튜브를 부풀려 튜브의 과열 압력을 크게 감소시킬 수 있으므로 유의하십시오.

**警告:** 圧力のかかったポリマーチューブを扱うときは、注意してください。

- 加圧されたポリマーチューブの付近では、必ず保護メガネを着用してください。
- 近くにある火を消してください。
- 著しく変形した、または折れ曲がったチューブは使用しないでください。
- 非金属チューブには、テトラヒドロフラン(THF)や高濃度の硝酸または硫酸などを流さないでください。

塩化メチレンやジメチルスルホキシドは、非金属チューブの膨張を引き起こす場合があります、その場合、チューブは極めて低い圧力で破裂します。





**Warning:** The user shall be made aware that if the equipment is used in a manner not specified by the manufacturer, the protection provided by the equipment may be impaired.

**Attention:** L'utilisateur doit être informé que si le matériel est utilisé d'une façon non spécifiée par le fabricant, la protection assurée par le matériel risque d'être défectueuses.

**Vorsicht:** Der Benutzer wird darauf aufmerksam gemacht, dass bei unsachgemäßer Verwendung des Gerätes die eingebauten Sicherheitseinrichtungen unter Umständen nicht ordnungsgemäß funktionieren.

**Attenzione:** si rende noto all'utente che l'eventuale utilizzo dell'apparecchiatura secondo modalità non previste dal produttore può compromettere la protezione offerta dall'apparecchiatura.

**Advertencia:** el usuario deberá saber que si el equipo se utiliza de forma distinta a la especificada por el fabricante, las medidas de protección del equipo podrían ser insuficientes.

**警告:** 使用者必須非常清楚如果設備不是按照製造廠商指定的方式使用，那麼該設備所提供的保護將被削弱。

**警告:** 使用者必須非常清楚如果設備不是按照製造廠商指定的方式使用，那麼該設備所提供的保護將被削弱。

**경고:** 제조업체가 명시하지 않은 방식으로 장비를 사용할 경우 장비가 제공하는 보호수단이 제대로 작동하지 않을 수 있다는 점을 사용자에게 반드시 인식시켜야 합니다.

**警告:** ユーザーは、製造元により指定されていない方法で機器を使用すると、機器が提供している保証が無効になる可能性があることに注意して下さい。



**Warning:** To protect against fire, replace fuses with those of the type and rating indicated in the “Replacing fuses” section of the Maintenance Procedures chapter.



**Attention:** pour éviter tout risque d'incendie, remplacez toujours les fusibles par d'autres du type et de la puissance indiqués dans la rubrique "Remplacement des fusibles" du chapitre traitant des procédures de maintenance.



**Vorsicht:** Zum Schutz gegen Feuer die Sicherungen nur mit Sicherungen ersetzen, deren Typ und Nennwert im Abschnitt "Sicherungen ersetzen" des Kapitels "Wartungsverfahren" angegeben sind.



**Attenzione:** per garantire protezione contro gli incendi, sostituire i fusibili con altri dello stesso tipo aventi le caratteristiche indicate nel paragrafo "Sostituzione dei fusibili" del capitolo "Procedure di manutenzione".



**Advertencia:** Para evitar incendios, sustituir los fusibles por aquellos del tipo y características indicados en la sección "Sustituir fusibles".



**警告:** 為了避免火災，更換保險絲時，應使用「維護步驟」章節中「更換保險絲」所指定之相同類型與規格的保險絲。



**警告:** 为了避免火灾，应更换“维护步骤”一章的“更换保险丝”一节中介绍的相同类型和规格的保险丝。



**경고:** 화재의 위험을 막으려면 유지관리 절차 단원의 “퓨즈 교체” 절에 설명된 것과 동일한 타입 및 정격의 제품으로 퓨즈를 교체하십시오.











**警告:** 火災予防のために、ヒューズ交換ではメンテナンス項目の「ヒューズの交換」に記載されているタイプおよび定格のヒューズをご使用ください。

# Electrical and handling symbols

---



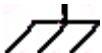
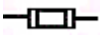

## Electrical symbols

These can appear in instrument user manuals and on the instrument's front or rear panels.

|   |  |
|---|--|
|    | Electrical power on                                |
|    | Electrical power off                               |
|    | Standby  |
|    | Direct current                                     |
|    | Alternating current                                |
|   | Protective conductor terminal                      |
|  | Frame, or chassis, terminal                        |
|  | Fuse   |
|  | Recycle symbol: Do not dispose in municipal waste. |

## Handling symbols

These handling symbols and their associated text can appear on labels affixed to the outer packaging of Waters instrument and component shipments.

|   |               |
|---|---------------|
|  | Keep upright! |
|  | Keep dry!     |
|  | Fragile!      |
|  | Use no hooks! |

# B Specifications

## 2414 refractive index detector specifications

---

Refer to the following tables for 2414 detector specifications.

### Operational specifications

| Condition                       | Specification   |
|---------------------------------|---|
| RI Range                        | 1.00 to 1.75 RIU  |
| Measurement Range               | $5 \times 10^{-4}$ RIU<br>$7 \times 10^{-9}$ RIU  |
| Flow Rate                       | 0.1 to 10 mL/min  |
| Noise <sup>a</sup>              | $\pm 1.5 \times 10^{-9}$ RIU, in RIU mode (Hamming filter TC = 2, ambient temperatures 23 to 25°C ( $\pm 2$ °C/hr), 1 mL/min. 100% water.<br>$\pm 3.0 \times 10^{-9}$ RIU, in 410 mode (RC filter TC = 1, ambient temperatures 23 to 25°C ( $\pm 2$ °C/hr), 1 mL/min. 100% water. |
| Drift <sup>a</sup>              | $2.0 \times 10^{-7}$ RIU/hr   |
| RIU-FS Settings (RIU mode)      | $1.0 \times 10^{-6}$ to $5.0 \times 10^{-4}$ RIU  |
| Sensitivity Settings (410 mode) | 1, 2, 4, 8, 16, 32, 64, 128, 256, 512, 1024   |
| Time Constant Filter Settings   | 0.0 to 5.0 seconds (Hamming)<br>0.0 to 10.0 (RC)<br>0.2, 1, 3, 10 seconds (RC under software data control)  |

### Operational specifications (Continued)

| Condition           | Specification   |
|---------------------|---|
| Analog Outputs      | -2.0 to +2.0 V  |
| Temperature Control | Internal oven: 30 to 55 °C (86 to 131 °F)<br>One external column heater:<br>Ambient to 150 °C (302 °F), steel |

a. Measurement taken after a minimum 2-hour warmup time or longer for equilibration, depending on column heater.

### Optical component specifications

| Conditions             | Specifications                          |
|------------------------|---|
| Light Source           | Light emitting diode (LED)              |
| Flow Cell              | Fused quartz                            |
| Cell Volume            | 10 µL                                   |
| Pressure Limit         | 100 psi                                 |
| Fluidic Path Materials | 316 stainless steel, PTFE, peek, quartz |

### Environmental specifications

| Conditions                       | Specifications                |
|----------------------------------|-------------------------------|
| Operating Temperature            | 15 to 32.2 °C (59 to 90 °F)   |
| Operating Humidity               | 20 to 80%, noncondensing      |
| Shipping and Storage Temperature | -40 to 70 °C (-104 to 158 °F) |
| Shipping and Storage Humidity    | 0 to 90%, noncondensing       |

### Dimensions

| Conditions | Specifications     |
|------------|--------------------|
| Height     | 20.8 cm (8.2 in.)  |
| Length     | 50.3 cm (19.8 in.) |
| Width      | 28.4 cm (11.2 in.) |
| Weight     | 11.4 kg (25 lbs.)  |

## Electrical specifications

| Conditions        | Specifications                           |
|-------------------|--|
| Line Frequency    | 50 Hz, 47 to 53 Hz<br>60 Hz, 57 to 63 Hz |
| Fuse Rating       | Fast 3.15 A, 250 VAC                     |
| Power Consumption | 145 VA (Nominal)                         |

## Power source specification

|                        |
|------------------------|
| <b>Nominal Voltage</b> |
| 100 to 240 V, 50/60 Hz |





# Index

---

## Numerics

- 2414 detector
  - setting up to run 5-16, 5-30
  - startup procedures 5-2
- 410 mode home screen. See 410 mode home screen
- 746 data system 3-16

## A

- adjusting
  - analog signal 5-16
  - contrast 5-34
- Alliance Separations Module
  - generating a chart mark from 3-14
- analog signals 1-22, 3-2, 3-10, 3-17, 7-21
- angle
  - of incidence 1-5
  - of refraction 1-5
- auto zero
  - configuring 5-33
  - enabling 5-16
  - function 5-16
  - generating 3-13
  - on inject parameter 5-16
  - signal connections 3-19

## B

- baseline
  - abnormal 7-16
  - cycling 7-16
  - drift 7-18
  - noise 6-2, 7-16
  - stable 4-5
  - troubleshooting 7-17, 7-24
- biohazard warning A-3
- burst warning A-3

- bus SAT/IN module 3-18

## C

- caution symbol A-4
- changing
  - time constant 5-13, 5-27
- chart mark
  - configuring event inputs 5-32
  - enabling 5-16
  - generating from the Alliance Separations Module 3-14
  - signal 3-19
- chemical hazard warning A-4
- chromatography troubleshooting 7-16
- column heater connections 3-2
- configuration screens 5-31
- configuring
  - auto zero event input 5-33
  - event inputs 5-32
- connections
  - 746 data module 3-16
  - Alliance Separations Module 3-12
  - auto zero 3-19
  - column heater 3-2, 3-23
  - inject start 3-8
  - input and output 3-11
  - integrator signal 3-18
  - manual injector 3-10
  - to a data system 3-2, 3-5
  - to a PowerLine controller 3-7
  - to drip tray 2-7
  - to waste 2-7
  - to Waters data systems 3-5
  - tubing 6-2
  - using the bus SAT/IN 3-18
  - Waters injector 3-19
- connections, fluid. See fluid path

connections, power. See power connections  
contact closures  
    configuring event inputs 5-32  
contacting Waters Technical Service 7-14

contrast  
    adjusting 5-34  
    function 5-34  
CPU board 1-23  
current method conditions 5-13

## D

damage reporting 2-4  
data system 3-18  
data system, connections 3-2, 3-5  
default IEEE-488 address 5-32  
degassing  
    considerations 4-7  
    solvent 4-5  
delta n, definition 1-7  
density, effect on RI 1-3  
detector  
    access to 2-2  
    dimensions 2-2, B-2  
    electronics 1-22  
    fuse replacement 6-4  
    installing 2-1  
    optics bench assembly 1-21, 1-22  
    power requirements 2-3  
    pressure relief valve 1-20  
    rear panel 3-3  
    remote mode 5-30  
    serial number 2-4  
    shutdown procedures 5-39  
    site selection 2-3  
    specifications B-1  
    storing 5-39  
detector temperature icon 5-11, 5-26

diagnostics  
    failure 5-3, 7-2  
    operation 3-8  
    procedure 7-7  
    startup 5-2  
    sticky 5-11, 5-27, 7-7  
    user-selected 7-6  
dimensions 2-2, B-2  
disabling  
    inputs 5-13, 5-28  
display  
    home 5-10, 5-25  
    system information 5-35  
drift 7-16  
drip tray 2-7

## E

electrical symbols A-11  
electronics 1-22  
enabling  
    auto zero 5-16  
    chart mark 5-16  
    chart mark event inputs 5-32  
    inputs 5-13, 5-28  
    purge 5-16  
    recycle 5-16  
errors  
    startup 7-2  
Ethernet  
    connections 3-4  
event inputs  
    auto zero 5-33  
    chart mark 5-32  
    configuring 5-32  
    inject start 5-32  
external column heater. See column heater

## F

failure of startup diagnostics tests 5-3

filter type function 5-15

filters

- changing the filter type 5-13, 5-27
- time constant 5-15

flow cell

- cleaning 6-2
- maximum pressure rating 1-20
- structure 1-19
- troubleshooting 7-18

fluid connections

- location 2-6
- to a column 2-7
- to drip tray 2-7
- to waste 2-7

fluid path

- cleaning 6-2
- components 1-18
- connections 2-5

functions

- auto zero 5-16
- primary 5-14, 5-29
- RIU offset 5-16
- scale 5-25, 5-38
- secondary 5-14, 5-29
- time constant 5-15
- trace 5-25, 5-38
- zoom 5-38

fuse

- faulty 6-4
- installation 2-4
- replacement 6-4

## G

gas solubility 4-5

guidelines

- sensitivity 5-35

## H

handling symbols A-12

heat exchanger, countercurrent 1-19

home screen

- display 5-2
- secondary pages 5-17, 5-30

## I

icons

- detector temperature 5-11, 5-26
- keypad lock 5-11, 5-27
- local/remote control 5-12
- method number 5-12
- next 5-12, 5-27
- RIU 5-11
- run time 5-12
- sensitivity 5-26
- shift 5-11, 5-26
- sticky diagnostics 5-11, 5-27
- table of 5-11, 5-26
- wrench 5-11, 5-27

IEEE-488

- address 3-8
- connections to Waters data systems 3-5
- default address 5-32
- setting the address 3-8, 5-32

initial method conditions 5-32

initializing the detector 5-2

inject signal 5-32

inject start

- connection 3-8
- signal 3-8

injection trigger signals 3-19

injector, connecting to a manual 3-10

input and output connectors 3-11

inputs

- disabling 5-13, 5-28
- enabling 5-13, 5-28

installation

- of fuses 2-4
- site requirements 2-3

integrator  
output 5-35  
signal 3-18

## K

keypad  
description 5-5  
functions 5-3  
illustration 5-4  
keys 5-5  
numerical keys 5-7  
up/down arrow keys 5-6  
using 5-3  
keypad lock icon 5-11, 5-27

## L

LED  
lens 1-21  
lens mask 1-21  
source lamp 1-21  
light path 1-21  
line spikes 7-14  
local/remote control icon 5-12  
lock icon 5-11, 5-27

## M

method  
current conditions 5-13  
initial conditions 5-32  
method number icon 5-12

## N

navigating the user interface 5-9  
next icon 5-12, 5-27  
noise  
adjusting filter 5-15  
increased peak 7-26  
long-term cycling 7-20  
short-term cycling 7-19  
troubleshooting 7-16

numerical keys 5-7

## O

offset  
uRIU 5-13  
voltage 5-13, 5-28  
operating specifications B-1  
operation problems 6-2  
operator interface 5-10, 5-25  
optics bench assembly 1-22  
components 1-21  
light path 1-21  
output voltage 5-14  
output voltage, changes in 1-10

## P

parameters  
auto zero on inject 5-16  
effects 5-35  
setting values 5-35  
peak  
identification 7-25  
qualification 7-25  
quantitation 7-25  
resolution 7-16, 7-23  
photodiode, dual-element  
light path 1-21  
output signal 1-9  
power  
requirements 2-3  
specifications B-3  
surges 7-14  
PowerLine controller, connecting to 3-7  
pressure changes 7-21  
pressure relief valve 1-20  
primary functions 5-14, 5-29  
problems in RI detection 1-10  
programming switches 5-33  
purge, enabling 5-16

## R

- rear panel
  - fuse holder 3-3
  - power input 3-3
- recycle
  - enabling 5-16
- refraction
  - angle of 1-5
  - measuring 1-5
- refractive index 1-5
  - angle relationships 1-5
  - definition 1-2
  - detection problems 1-10
  - measurements 1-7
- refractive index units. See RIU
- refractometer, 2414
  - access to 2-2
  - connecting to data systems 3-5
  - connections to 746 3-16
  - dimensions 2-2, B-2
  - electronics 1-22
  - injection trigger signal connections 3-19
  - installation procedure 2-1
  - integrator signal 3-18
  - manual injector 3-10
  - optics bench assembly 1-21, 1-22
  - power requirements 2-3
  - powering-off 5-39
  - rear panel 3-3
  - remote mode 5-30
  - replacing a fuse 6-4
  - serial number 2-4
  - site selection 2-3
  - specifications B-1
- refractometer, 2414 fluid path 1-18
- relief valve 1-20
- remote
  - LED indicator 5-30

- remote operating mode 5-30
- reproducibility
  - errors 7-23
  - results 4-5
- results
  - reproducibility 4-5
  - troubleshooting 7-16, 7-25
- retention times
  - erratic 7-16
  - troubleshooting 7-16
- RIU
  - icon 5-11
  - offset parameter 5-16
  - relationship to output voltage 5-14
- RIU home screen display 5-10, 5-25
- RIU-FS
  - defined 5-14
  - function 5-14
- run time icon 5-12

## S

- safety advisories A-1
- scale function 5-25, 5-38
- screen
  - icons 5-11, 5-26
- screens
  - home 5-2, 5-10, 5-25
- secondary functions 5-13, 5-14, 5-27, 5-29
- secondary pages 5-17, 5-30
- sensitivity
  - function 1-11
  - guidelines 5-35
  - icon 5-26
- serial number, locating 2-4
- setting
  - detector up to run 5-16, 5-30
  - IEEE addresses 5-32
- setting the IEEE-488 address 5-32

- shift icon 5-11, 5-26
- signal connections
  - Alliance Separations Module 3-12
  - auto zero 3-19
  - chart mark 3-14, 3-19
  - inject start 3-8
  - injection trigger 3-19
  - input and output 3-11
  - integrator 3-18
  - making 3-5
  - manual injector 3-10
  - to 746 3-16
  - to a data system 3-18
  - to a PowerLine controller 3-7
- signal start of run 5-32
- Snell's law 1-5
- solenoid valve 1-20
- solvent
  - common problems 4-2
  - degassing 4-5
  - general considerations 4-2
  - ideal 4-2
  - refractive indices 4-3
- source lamp 1-21
- specifications
  - detector B-1
  - power source B-3
- starting
  - detector 5-2
  - run 5-32
- startup
  - diagnostics 5-2
  - diagnostics failure 5-3
  - errors 7-2
- sticky diagnostics 5-11, 5-27, 7-7
- switches, programming 5-33
- symbols
  - caution A-4
  - electrical A-11

- handling A-12
- warning A-2
- system information 5-35

## T

- time constant
  - changing 5-13, 5-27
  - function 5-15
- trace function 5-25, 5-38
- transient energy 7-14
- troubleshooting
  - baseline cycling 7-16
  - baseline drift 7-16, 7-17, 7-18
  - baseline noise 7-16
  - chromatography 7-16
  - contacting Waters 7-14
  - flow cell 7-18
  - hardware 7-15
  - peak shapes 7-16, 7-23, 7-25
  - pressure changes 7-21
  - qualitation 7-25
  - quantitation 7-25
  - reproducibility 7-23
  - resolution 7-16, 7-23
  - results 7-16, 7-25
  - retention times 7-16
  - tables 7-16
- tubing
  - contaminated 6-2
  - cutting 2-7

## U

- up/down arrow keys 5-6
- uRIU offset parameter 5-13
- user interface 5-9
- user-selected diagnostics 7-6
- using
  - keypad 5-3
  - scale function to zoom 5-38

## V

### valves

- pressure relief [1-20](#)

- solenoid [1-20](#)

### voltage

- operating [B-3](#)

### voltage offset

- function [5-13](#), [5-16](#), [5-28](#)

## W

### warning symbols [A-2](#), [A-4](#)

### waste

- connections to [2-7](#)

- container [6-3](#)

- line [2-7](#)

### Waters Technical Service, contacting

- [7-14](#)

### wrench icon [5-11](#), [5-27](#)

## Z

### zoom function [5-38](#)

